

# DAKOTA DUNES INTERCHANGE JUSTIFICATION STUDY

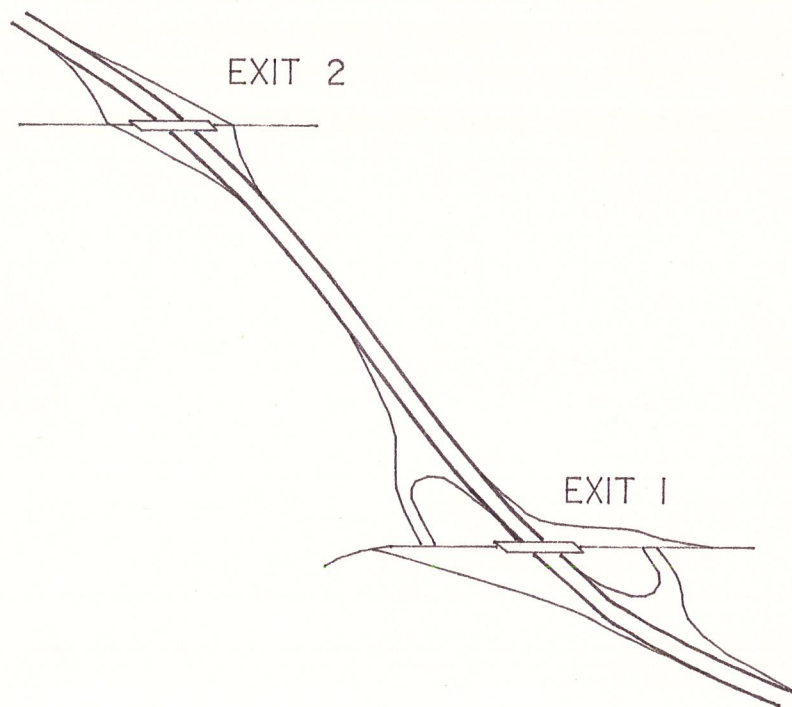

SEPTEMBER 1989

PREPARED BY:

SOUTH DAKOTA DEPARTMENT OF TRANSPORTATION  
DIVISION OF PLANNING  
OFFICE OF PLANNING AND PROGRAMMING  
700 BROADWAY AVENUE EAST  
PIERRE, SOUTH DAKOTA 57501

## TABLE OF CONTENTS

Project Overview	Page 1
Land Use in the Project and Its Relationship to Highway Improvement Plans and Programs	Page 10
Description of Interchange Alternatives and Phasing	Page 13
Preferred Alternative (Alternative 1) Interchange at Milepost One	Page 17
Interchange Design Options for Milepost One	Page 20
Traffic Assumptions and Assignments	Page 34
Existing Traffic and Projected Traffic Impacts	Page 38
Cost Benefit Analysis	Page 57
Sources of Funding	Page 58

## LIST OF FIGURES

Figure 1	Dakota Dunes	Page 2
Figure 2	Dakota Dunes Regional Siting	Page 4
Figure 3	Dakota Dunes (overall plan)	Page 5
Figure 4	Dakota Dunes Schedule of Development	Page 7
Figure 5	Location of Cities Near Dakota Dunes	Page 11
Figure 6	Plan View Proposed Milepost 1 Interchange	Page 21
Figure 7	Plan and Profile Milepost 1 Crossroad	Page 24
Figure 8	Plan and Profile Ramp A Milepost 1	Page 25
Figure 9	Plan and Profile Ramp B Milepost 1	Page 26
Figure 10	Plan and Profile Ramp C Milepost 1	Page 27
Figure 11	Plan and Profile Ramp D Milepost 1	Page 28
Figure 12	Plan and Profile Ramp E Milepost 1	Page 29
Figure 13	Plan and Profile Ramp F Milepost 1	Page 30
Figure 14	Typical Grading Sections	Page 31
Figure 15	Traffic Analysis Zones	Page 37
Figure 16	1989 Average Daily Traffic at M.P. 2	Page 39
Figure 17	1989 Peak Hour Traffic at M.P. 2	Page 40
Figure 18	1989 Peak Hour Level of Service at M.P. 2	Page 41
Figure 19	20 Year Projected ADT Interchanges at M.P. 1 and M.P. 2	Page 43
Figure 20	20 Year Projected A.M. Peak Hour Traffic and Level of Service Interchanges at M.P. 1 and M.P. 2	Page 44
Figure 21	20 Year Projected P.M. Peak Hour Traffic and Level of Service Interchanges at M.P. 1 and M.P. 2	Page 45

Figure 22	Design Hour Volumes (Full Build Out) Interchanges at M.P. 1 and M.P. 2	Page 46
Figure 23	Level of Service Comparison of Proposed Interchange Designs	Page 48
Figure 24	Intersection Analysis at Milepost 1 Modified Diamond Interchange with Free-flow Ramp in Southwest Quadrant	Page 49
Figure 25	Intersection Analysis at Milepost 1 Modified Diamond Interchange with Free-flow Ramp in Southwest Quadrant	Page 50
Figure 26	Intersection Analysis at Milepost 1 Diamond Interchange	Page 51
Figure 27	Intersection Analysis at Milepost 2 With Interchange at Milepost 1	Page 53
Figure 28	Intersection Analysis at Milepost 2 Without Interchange at Milepost 1	Page 54
Figure 29	Projected Peak Hour Volume and Level of Service Exit 150 Near the Riverside Neighborhood	Page 56
Figure 30	Source of Funding for Interchange Improvements	Page 59



## DAKOTA DUNES INTERCHANGE JUSTIFICATION STUDY

### Project Overview

Dakota Dunes is a planned business park and residential community which will be located in the southern tip of Union County, South Dakota. Midwest Energy Company is the sponsor of this planned development. At the present time the company has purchased approximately 2,000 acres of land for development in Union County as shown in Figure 1. The ground breaking for the golf course has taken place.

At full build out, in 2008, it is projected that this development will employ approximately 6,000 people. Due to the large number of employees, and the fact that Dakota Dunes will be bisected by I-29, an interchange needs to be constructed near milepost one to provide access in closer proximity to the development than the existing interchange at milepost two, which is located approximately 1.4 miles to the north. The new interchange will facilitate access from the residential and commercial neighborhoods to the office research park area, provide time and distance savings to travelers, and accommodate the projected traffic that will be generated by Dakota Dunes employees. The new interchange will not adversely affect the operation of the Interstate main line.

There is strong support for the project from the state, regional, and local levels as shown by the letters of support contained in the appendix.

### Project Setting

The Dakota Dunes development is located just to the north of the confluence of the Missouri River and the Big Sioux River. The development is within 5 miles of the Sioux City metropolitan area and North Sioux City lies

FIGURE 1

# DAKOTA DUNES

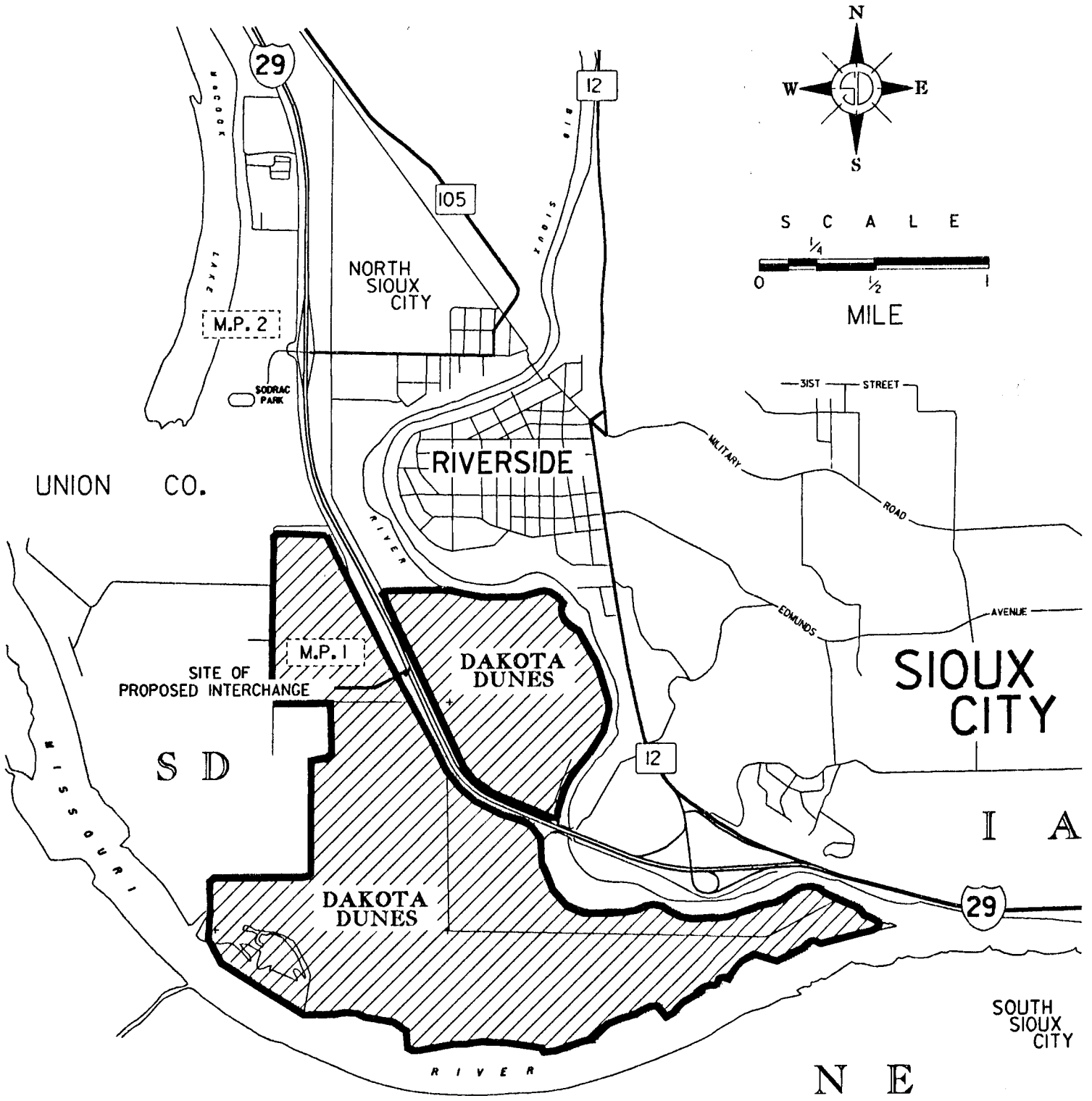

about one mile to the northeast. The site is centrally located between I-90, which is approximately 75 miles to the north, and I-80 which is about 80 miles to the south, as shown in Figure 2. By way of I-29, Sioux Falls, South Dakota is 75 miles north of Dakota Dunes and Omaha, Nebraska is 80 miles south of the project site. The development is also situated so access is readily available to major railroad and airport facilities.

### Project Elements

The overall plan for Dakota Dunes is shown in Figure 3. As presently envisioned the development will consist of three major elements:

1. The development on the east side of I-29 will include the existing Dakota Dunes Golf Course (former Boat Club Golf Course), a 200 room hotel, and a business park which will include corporate office buildings and research centers.
2. On the west side of I-29 the development will include a 360,000 square foot shopping center, an elementary school, a marina, apartments, and flex space.
3. Also on the west side of I-29, a residential community developed around a championship golf course will be built. This planned community will contain 1165 total dwelling units, of which 715 will be residential homes, 150 will be condominiums, and 300 will be apartments.

### Project Land Use Plan

The land use plan for the development essentially reserves the I-29 frontage for corporate, business, and commercial uses. The business park will offer a variety of site opportunities for high image corporate headquarters as well as general office, research facilities, light manufacturing, and flex space uses.

The commercial center's orientation is such that available sites will be exposed to the interchange as well as traffic generated by the business park

FIGURE 2

# DAKOTA DUNES REGIONAL SITING

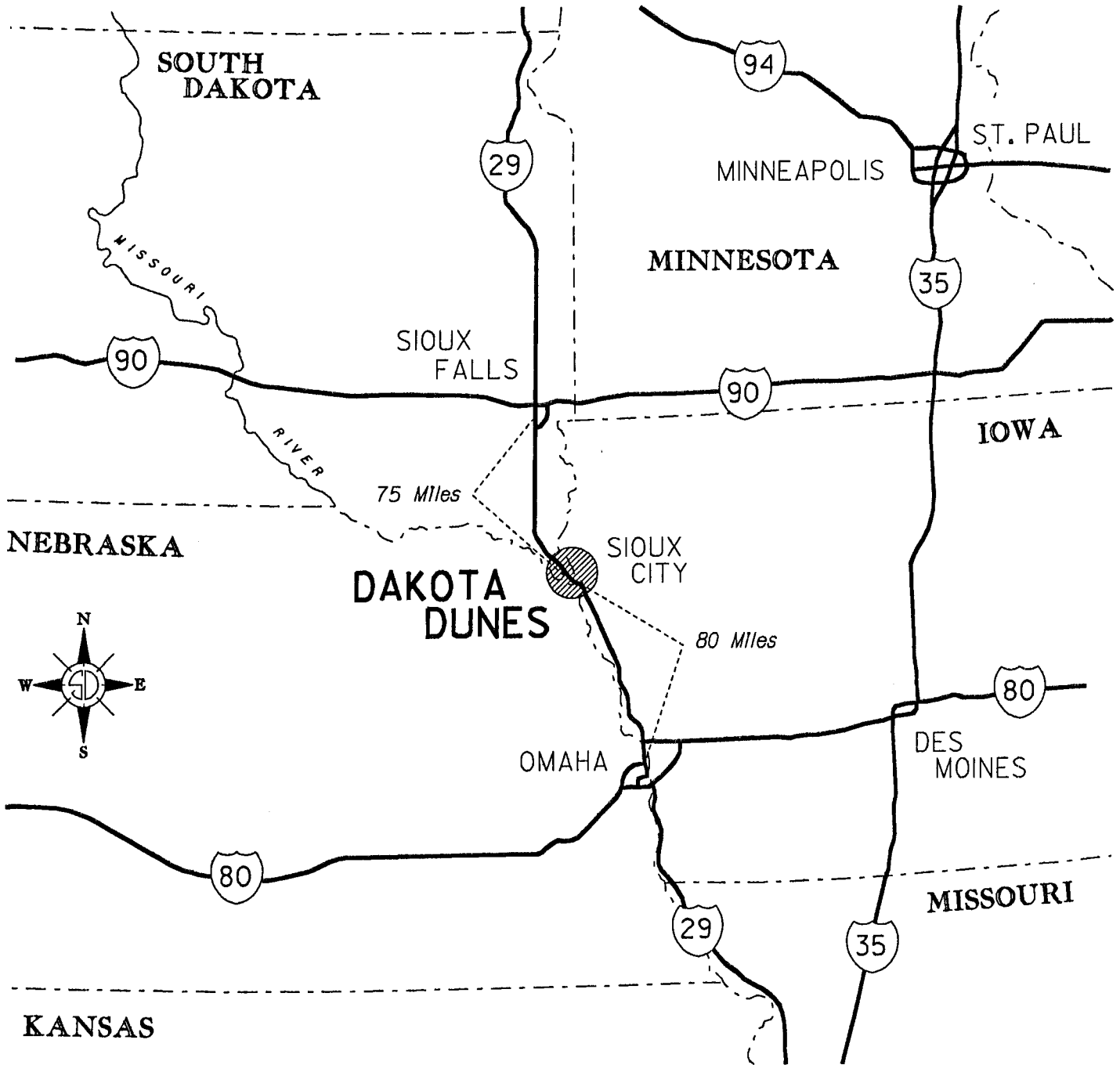
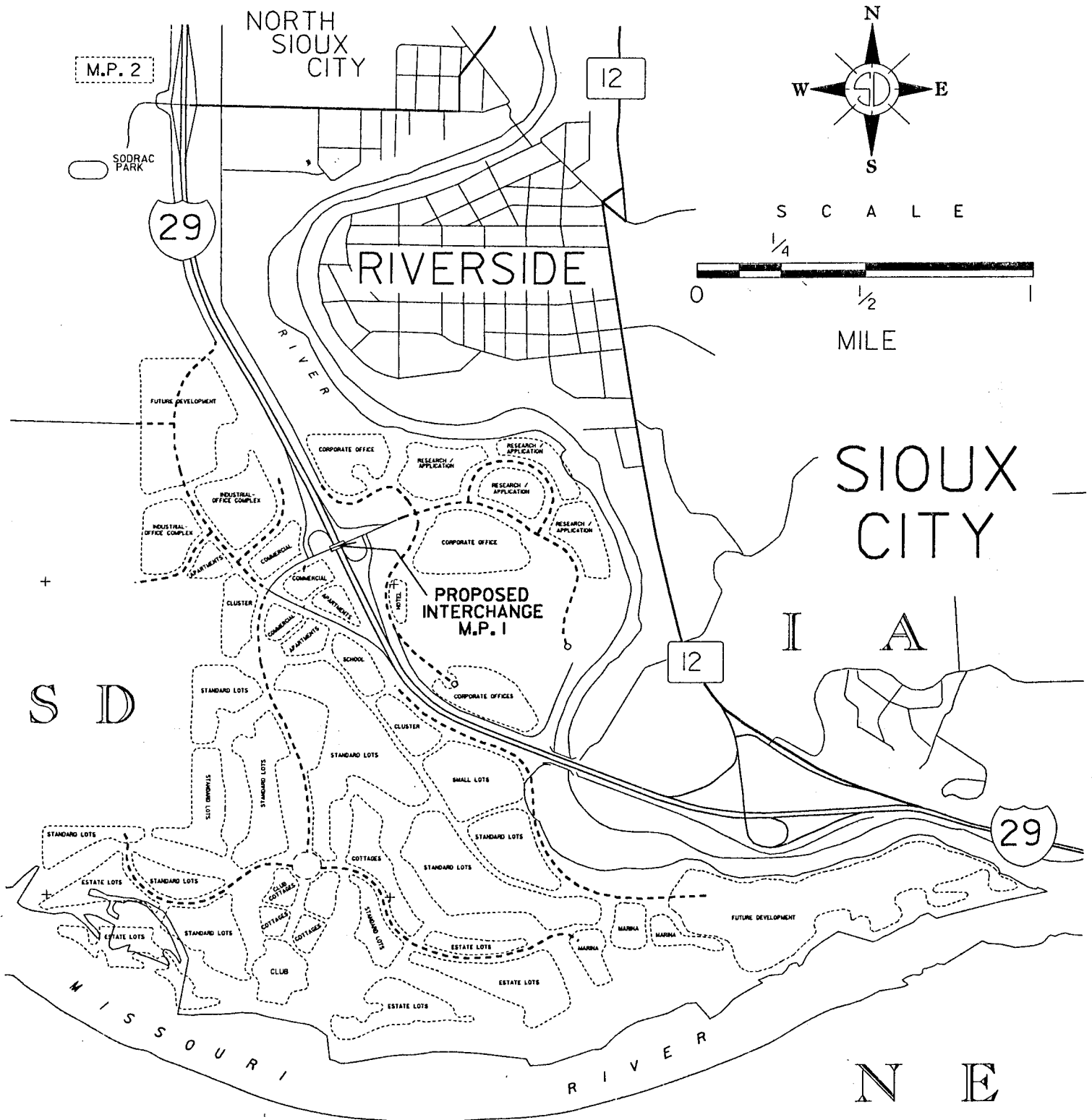

FIGURE 3

# DAKOTA DUNES



and residential communities. It will include a neighborhood shopping center, general commercial areas, personal services, financial services, and convenience facilities.

The residential community is planned to provide a variety of quality housing types. The golf course community features single family units which include large estate lots within sight of a secluded river-oriented setting. Parcels for housing types such as apartments, condominiums, and cottages are also provided. Figure 4 shows the Dakota Dunes cumulative schedule of development in five year increments. This schedule was developed based upon the interchange being in place in the spring of 1991.

FIGURE 4  
DAKOTA DUNES SCHEDULE OF DEVELOPMENT\*

<u>CLASSIFICATION</u>	<u>1993</u>	<u>1998</u>	<u>2003</u>	<u>2008</u>
HOTEL (ROOMS)	----	200	200	200
SHOPPING CENTER (SQUARE FEET)	50,000	300,000	360,000	360,000
LIGHT INDUSTRY (EMPLOYEES)	380	950	1,898	2,050
OFFICE PARK (EMPLOYEES)	490	1,265	1,776	2,150
RESEARCH CENTER (EMPLOYEES)	220	417	765	800
GOLF (ACRES)	359	359	359	359
MARINA (BERTHS)	----	300	300	300
ELEMENTARY SCHOOL (STUDENTS)	----	----	500	500
RESIDENTIAL (UNITS)	119	493	680	715
APARTMENTS (UNITS)	----	150	300	300
CONDOMINIUMS (UNITS)	20	85	140	150

\* The numbers shown in this figure should not be added. They represent the level of development which will exist at that point in time.

## PURPOSE OF THE INTERCHANGE

### Economic Development

Construction of an interchange facility at milepost one is viewed as an essential component in the overall plan for Dakota Dunes. The construction of an interchange to serve Dakota Dunes will enhance economic development in the project area; provide user benefits for the employers, employees, and residents of Dakota Dunes; and, provide long term economic benefits for the entire region. It will not create an unacceptable level of service on I-29.

At full build out in 20 years, it is estimated there will be 3,190 people living in the Dakota Dunes development and 6,000 people will be working there. With the combination of people living or working, or both, in the development, and the development bisected by I-29, an interchange to allow direct east-west access to the development is viewed as a necessity to reduce trip length on the interstate and to provide additional access for safety purposes in case an interchange should become blocked.

### Project Accessibility

Without an interchange at milepost one, all the access to the property at Dakota Dunes would have to occur at the milepost two interchange and more extensive frontage roads would have to be constructed on both sides of the interstate. As more development occurred, this indirect access would become an increasingly undesirable and create a hazardous situation because of the additional travel time and distance required for large volumes of traffic. Without the interchange at milepost one, it would be wise to reconstruct the "interstate over interchange" at milepost two as soon as possible because of



the difficulty of routing large traffic volumes through the project as it is reconstructed, although it may be possible to do so. If milepost two were the only interchange accessing the development, the attractiveness of the development would be stifled during reconstruction, which would make it difficult to recruit new industry. Also, should this interchange become blocked during reconstruction, access for fire equipment or an ambulance would become even more difficult. The existing interchange structures at milepost two were constructed in 1981 and timely reconstruction would cause 40 years of service life to be lost.

## LAND USE IN THE PROJECT AREA AND ITS RELATIONSHIP TO HIGHWAY IMPROVEMENT PLANS AND PROGRAMS

### Existing Land Use

The existing land use in the project area is agricultural and farming. Land use in close proximity to the development is varied. Along the east side of I-29 are a trailer park, a school, several industries and the Gateway Industrial Park. On the west side of I-29, are housing developments, a trailer park, a school, Sodrac Park dog racing track, and some scattered residences.

Several cities in the vicinity of Dakota Dunes are shown in Figure 5. About one mile to the north is North Sioux City, South Dakota which has a population of approximately 2,500 people. Directly across the Big Sioux River to the south of North Sioux City lies Riverside, a neighborhood of Sioux City, Iowa with a population of approximately 2,500 people. The remainder of Sioux City is located southeast of Riverside and has a population of approximately 80,000 people. To the south of Sioux City, across the Missouri River, lies South Sioux City, Nebraska with a population of about 9,500 people. Data from the U.S. Census Bureau indicates that the Sioux City Metropolitan Statistical Area has a population of approximately 95,000 people.

In the initial phases of development, a large percentage of the traffic to the Dunes will come from the south. This is due to the location of the population base and the attraction offered by the employment opportunities which will be created in the new development. The major direction of traffic flow to Dakota Dunes provides additional justification for an interchange at

# FIGURE 5

## LOCATION OF CITIES NEAR DAKOTA DUNES

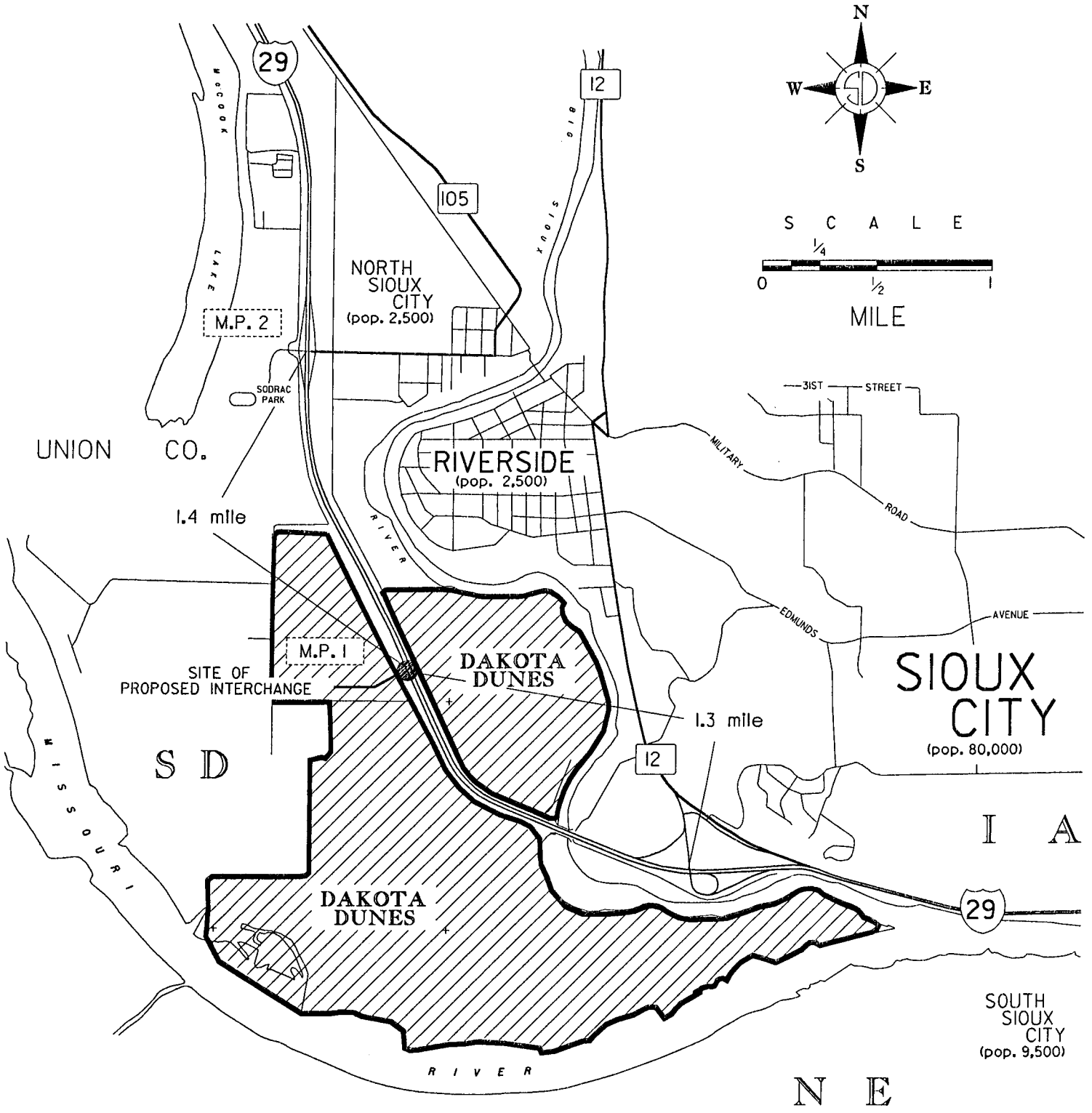

milepost one because of the time and distance savings for traffic that would not have to travel to milepost two for access.

#### Impacts On Existing Highway System

The proposed interchange at milepost one will have minimal impact on the existing system when construction activity begins. The distance from milepost one to milepost two is approximately 1.4 miles and the distance to the first interchange in Iowa is 1.3 miles. Sufficient distance is available between interchanges for traffic to safely merge or diverge and there will be no adverse impacts on the operation of these interchanges from the interchange at milepost one. The minimal impact of an interchange at milepost one on the service of the interstate is discussed later in this study.

Based on the current South Dakota Department of Transportation Highway Construction Program for 1989-1993, one project is scheduled in this area.

1. Project number IR 29-1(69)0, PCEM number 2994. This is a pavement restoration, joint and spall repair, project from the Iowa State line north for 15.2 miles on I-29. This project has been assigned a tentative letting date of March, 1992.

This project will be managed and designed to accommodate the increased traffic associated with the development.

The southbound bridge over the Big Sioux River on I-29 is being reconstructed during 1989. This project will be completed before construction will begin at milepost one.

## DESCRIPTION OF INTERCHANGE ALTERNATIVES AND PHASING

### Alternative 1 Components and Phasing

Three alternatives have been proposed for analysis, cost estimates, and preliminary design. The first alternative involves phased construction of an interchange at milepost one, frontage roads, and reconstruction and expansion of the interchange located at milepost two. With the construction of an interchange at milepost one, the existing interchange at milepost two should not be reconstructed as soon as possible and 15 more years of useful service life will be obtained from the current structures. Even though the service life of the structure is 54 years, it is estimated that the capacity of the interchange may be approached in 15 years and the interchange may need to be rebuilt. The cost of alternative one is \$12.438 million.

This alternative would be constructed in two phases. The first phase would be the complete construction of the interchange at milepost one. Portland Concrete Cement Paving (PCCP) would be limited to the frontage roads that would be needed immediately. The second phase, which would begin in the year 2003, would include PCCP on all of the frontage road lanes to the road width that would be needed at full build out and construction of a new interchange with more capacity at milepost two.

### Alternative 2 Components and Phasing

The second alternative would entail the phased reconstruction and expansion of the interchange located at milepost two. The major difference between the first and second alternative is no interchange is proposed at milepost one and more elaborate frontage roads would be needed on the east side of the interstate than are needed with the first alternative. With

alternative two, the interchange at milepost two, which is an interstate-over a four lane roadway, would be replaced as soon as possible with a five-lane roadway and 15 years of useful service life would not be obtained from the existing structures. A level of service analysis presented later in this study indicates the capacity may approach the margin of unacceptability. The cost of alternative two is \$7.473 million which is \$5 million less than alternative one but substantial travel time and distances are added to trips to the Dakota Dunes area and additional safety risks are incurred without the interchange at milepost one.

This alternative would also be constructed in two phases. The first phase would involve grading for a four lane frontage road on both sides of the interstate. Initially, two of the four lanes on each side would be PCCP and the other two lanes, which would access the reconstructed and expanded interchange at milepost two, would have a blotter surface. The interchange would be constructed with a new five lane crossroad under new structures during phase one. The reconstruction of the milepost two interchange would begin as soon as possible and would require the destruction of the structures which were built in 1981.

The second phase, which would be completed in 2003, would involve expansion of the frontage roads from two lanes to four lanes and paving the additional two lanes with PCCP. This would improve access to the developments that would be located adjacent to the interstate.

#### Alternative 3 Components and Phasing

The third alternative would consist of the phased reconstruction and expansion of the frontage roads without the construction of new interchanges. With this alternative, both the east and west side frontage roads would be

constructed immediately. The existing interchange at milepost two would not be expanded and no new interchange would be constructed at milepost one. The cost of alternative three would be \$3.878 million. As was the case with alternative two, substantial travel time and distances are added to trips to the Dakota Dunes area.

The third alternative would also be constructed in two phases. The first phase would construct both the east and west side frontage roads immediately. Both frontage roads would be four lanes in width. The two inside lanes on each side would be PCCP and the outside two lanes, which would serve as shoulders, would have a blotter surface.

The second phase, to be completed in 2003, would involve expansion of the frontage roads from two lanes with PCCP to four lanes with PCCP.

#### Alternative 4 Components and Phasing

The fourth alternative is a no build alternative.

### Preferred Alternative

The South Dakota Department of Transportation has designated the proposed construction of an interchange at milepost one as Alternative I which is the preferred alternative. Alternative 1 was designated as the preferred alternative because it will:

- \* Allow for more direct access to the development.
- \* Allow for ease of access from one side of the development to the other.
- \* Provide substantially greater user benefits than the other alternatives in the form of time and distance savings.
- \* Relieve congestion at the milepost two interchange.
- \* Maintain the level of service of Interstate 29 by increasing the number of access points to smooth and distribute the traffic.
- \* Allow the state to obtain approximately 15 years more useful service life out of the structures at milepost two.
- \* Increase the safety and emergency access opportunities should one of the interchanges become blocked.

The detailed elements and phasing of the preferred alternative follow:



## PREFERRED ALTERNATIVE (ALTERNATIVE 1): INTERCHANGE AT MILEPOST ONE

### Phase 1 Components

1. Excavating, hauling, and depositing 384,764 cubic yards of fill for approaches and enter and exit ramps along the interstate at milepost one. The shrinkage factor is 35 percent.
2. Construction of a 343 foot long crossroad bridge at milepost one, 60 feet wide, with four 12 foot portland cement concrete paved lanes, curb and gutter on the crossroads, and an eight foot sidewalk-bicycle path attached on the north side of the bridge.
3. All the ramps, except the northbound exit ramp, would be built with single 18 foot lanes, paved with portland cement concrete, and have three foot concrete shoulders on the inside and outside. The northbound exit ramp will be a two lane ramp requiring an auxiliary lane along I-29 to safely diverge the traffic from the interstate. The auxiliary lane would extend beyond the point where a single lane ramp would have diverged from the existing lanes.
4. The northwest quadrant loop ramp will have a 1,230 foot acceleration lane adjacent to I-29 and will taper into the existing pavement at a 50:1 ratio so that development traffic can safely reach the speed of the interstate traffic. The southeast quadrant loop ramp will create a 3,300 foot auxiliary lane to safely merge traffic from that ramp and the northeast quadrant tuck ramp with the interstate traffic.
5. Construction of a tucked ramp in the northeast quadrant for the traffic from the east side of the development desiring to travel north on I-29. This single lane ramp will be 18 feet wide and approximately 1,300 feet long. It will merge into the auxiliary lane created for Ramp A with a 1,000 foot taper.
6. Construction of a free-flow ramp in the southwest quadrant for traffic from the west side of the development desiring to travel south. This ramp, which is an extension of the west side frontage road, will begin at an intersection within the development, approximately 700 feet south of the crossroad intersection with the west side frontage road. This ramp will have two 12 foot wide lanes for approximately 1,250, where it will narrow into a single 18 foot wide lane with a 300 foot (50:1) taper. The ramp will continue as a single lane for approximately 600 feet where it will merge into the interstate with a 900 foot (50:1) taper.
7. Outside the project boundaries, the frontage road on the west side of the interstate would be constructed as a rural section, with two 12 foot portland cement concrete paved lanes and eight foot asphalt shoulders. The rural section would be a 40 foot finished roadway. Within the project boundaries, the road would be constructed to allow a phased urban section. The first phase would have two 12

foot portland cement concrete paved lanes, two 12 foot blotter shoulders, and curb and gutter.

## Phase 2 Components

1. Within the project boundaries, the frontage road on the west side would be expanded to four 12 foot portland cement concrete lanes up to the existing curb and gutter. Outside the project boundaries, two additional 12 foot portland cement concrete lanes would be added along with eight foot asphalt shoulders.
2. The frontage road on the east side of the interstate would be constructed with two 12 foot portland cement concrete paved lanes with curb and gutter for the full length of the project with eight foot concrete shoulders for parking.
3. The interchange at milepost two would be reconstructed to a five lane road under-the-interstate, with single lane ramps. New structures would be required.

The following table capsulizes the components of the preferred alternative indicating the timetable for completion and the corresponding costs.

PHASING OF IMPROVEMENTS AT DAKOTA DUNES  
PROJECT START UP 1989

PREFERRED ALTERNATIVE (ALTERNATIVE 1): INTERCHANGE AT MILEPOST 1

Construct interchange at milepost 1	IMMEDIATELY
Construct a 2 lane frontage road on the west side of the interstate.	2 YEARS
Construct a 2 lane frontage road on the east side of the interstate.	7 YEARS
Add an additional 2 lanes on frontage road on the west side of the interstate.	12 YEARS
Reconstruct the interchange at milepost 2.	15 YEARS

COST OF PREFERRED ALTERNATIVE

PREFERRED ALTERNATIVE (ALTERNATIVE 1): INTERCHANGE AT MILEPOST ONE

Phase 1

Interchange at milepost one	\$5.448 Million
West side frontage road	1.235 Million
<b>TOTAL</b>	<b>\$6.683 Million</b>

Phase 2

Expansion of west side frontage road	.567 Million
Build east side frontage road	1.593 Million
Reconstruct M.P. 2 interchange	3.595 Million
<b>TOTAL</b>	<b>\$5.755 Million</b>

<b>TOTAL COSTS FOR BOTH PHASES</b>	<b>\$12.438 Million</b>
------------------------------------	-------------------------

## INTERCHANGE DESIGN OPTIONS FOR MILEPOST ONE

### Modified Diamond Interchange With Free-Flow Ramp in SW Quadrant (Option 1)

Design Option 1 proposed at milepost one is a modified diamond (partial cloverleaf) shown in Figure 6. This interchange configuration consists of diamond legs for the northbound and southbound I-29 exit ramps (Ramps B & D). The entrances to I-29 from the crossroad will be loop ramps (Ramps A & C). A free-flow tucked ramp to be constructed at grade along the toe of the crossroad embankment for the westbound crossroad to northbound I-29 traffic (Ramp E). A free-flow ramp to the interstate which will be a continuation of the north-south frontage road on the west side will be constructed in the southwest quadrant (Ramp F).

The construction of the tuck ramp in the northeast quadrant and the free-flow ramp in the southwest quadrant will eliminate the left turns on the crossroad structure increasing the safety of the structure. In addition, the highest valued property in the development, which is located near the interchange, will be preserved for development.

All the ramps, except Ramp "B", will be constructed as single lane ramps. The northbound exit ramp "B" will be constructed as a two lane ramp to accommodate the heavy a.m. peak hour traffic volumes from the south anticipated when the development reaches full build out. The two lane ramp configuration will require an auxiliary lane along I-29, extending beyond the point where a single lane ramp would have diverged from the existing lanes, to safely diverge the traffic from the interstate. Loop Ramp "C" will have 1,230 foot acceleration lanes adjacent to I-29 and will taper into the existing pavement at a 50:1 ratio so that development traffic can safely reach the



speed of the interstate traffic. The southeast quadrant loop ramp "A" will create a 3,300 foot auxiliary lane to safely merge traffic from Ramp "A" and the tuck ramp "E" with the interstate traffic.

This option eliminates the left turn movements from vehicles desiring to go south from the western portion of the development and the left turn movements from the vehicles desiring to go north from the eastern portion are also eliminated. These left turn movements will be prohibited at the intersections of the crossroad and the loop ramps, thereby greatly improving the level of service at the first intersection and the ramp intersections.

Two other options were considered for Phase 2 of the modified diamond design. The second design option considered proposed that the free-flow ramp to the interstate to be constructed in the southwest quadrant be part of the interchange configuration as a tucked ramp. A second lane would still be added on the northbound I-29 exit. This option, unlike Option 1, would still require dual left turn lanes on the northern approach at the west side frontage road intersection.

The third design option considered for Phase 2 would involve adding a second lane on the northbound I-29 exit and southbound I-29 entrance ramps. The preliminary design for the two lane ramp configurations would require auxiliary lanes along the interstate to safely merge/diverge the traffic from the added lanes. These lanes would extend beyond the point where the single lane ramps merge/diverge from the existing lanes. With this option, no provision is made to provide direct access for vehicles from the western portion of the development desiring to travel south. As a result, dual left turn lanes would be required on the north approach of the west side frontage road intersection and on the west approach of the western ramp intersections

with the crossroad over the interstate, to provide an adequate level of service.

Figures 7, 8, 9, 10, 11, 12 and 13 are detailed plan and profile drawings of the individual ramps and crossroad. These drawings depict the intersections of the development access and frontage roads with the crossroad, however, the intersection locations shown are preliminary and could change slightly when the development's internal circulation system is finalized. The preliminary location for these intersections would place them approximately 1,200 feet from the centerline of the interstate on the east side of the development and 1,600 feet on the west side.

#### Design Criteria

The design criteria used for the preliminary plan included appropriate specifications from the 1984 AASHTO "Green Book" and information provided by the South Dakota Department of Transportation. The crossroad over the interstate is designed to have a maximum longitudinal grade of three percent with 4:1 side slopes starting approximately ten feet from the edge of the pavement. The ramps are designed with a maximum grade of two percent with 6:1 side slopes from the back of shoulder, except the tuck ramp in the northeast quadrant which is designed with a maximum grade of 2.35 percent. The loop ramps are designed with a 330 foot radius and a maximum superelevation of six percent which accommodates a design speed of approximately 35 mph.

The free-flow ramp "F" in the southwest quadrant will accommodate a 50 mph design speed and utilizes a 580 foot acceleration lane and a 900 foot taper (50:1) to safely merge the ramp traffic.

Typical sections for the crossroad and the ramps are shown in Figure 14.



# Figure 7 PLAN AND PROFILE Milepost 1 Crossroad

PLAN	DATE	
	BY	
PROFILE	DATE	
	BY	
SURVEYED PLANNED CHECKED NOTE BOOK NO. 141 STRUCTURE NO. 141/142/143/144		

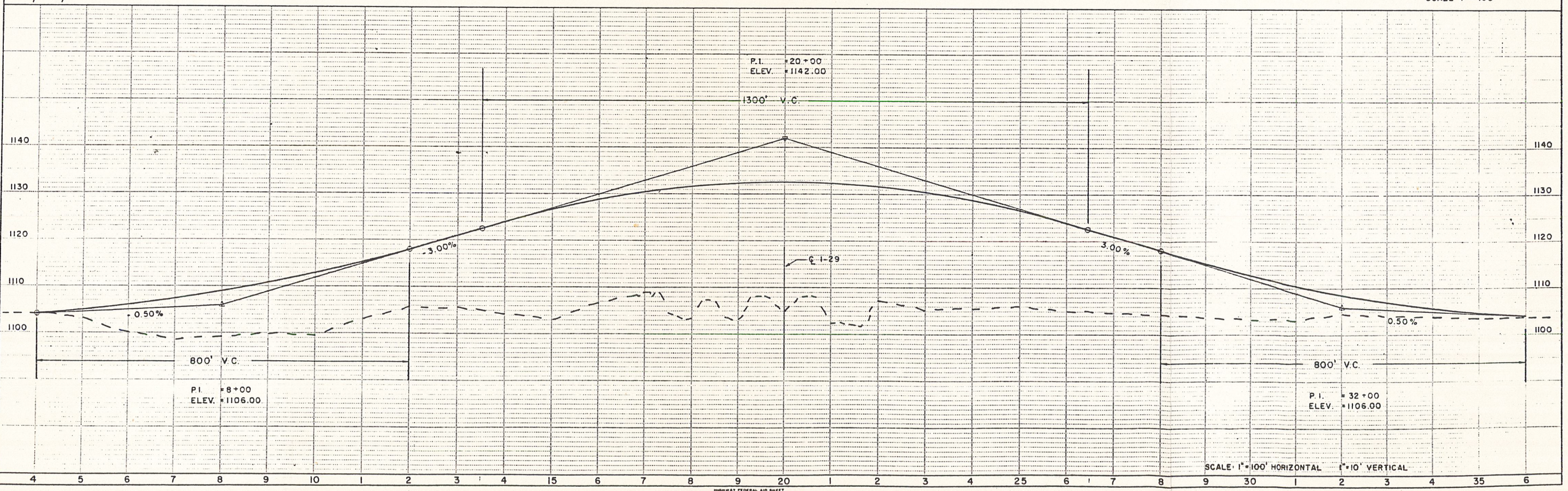
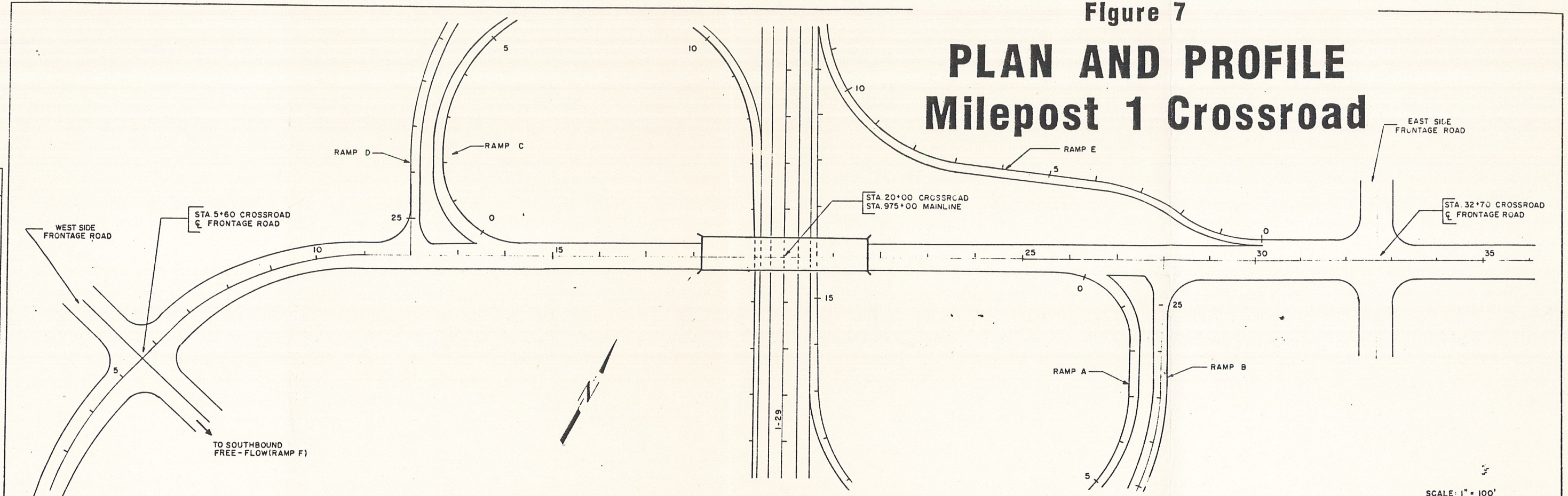

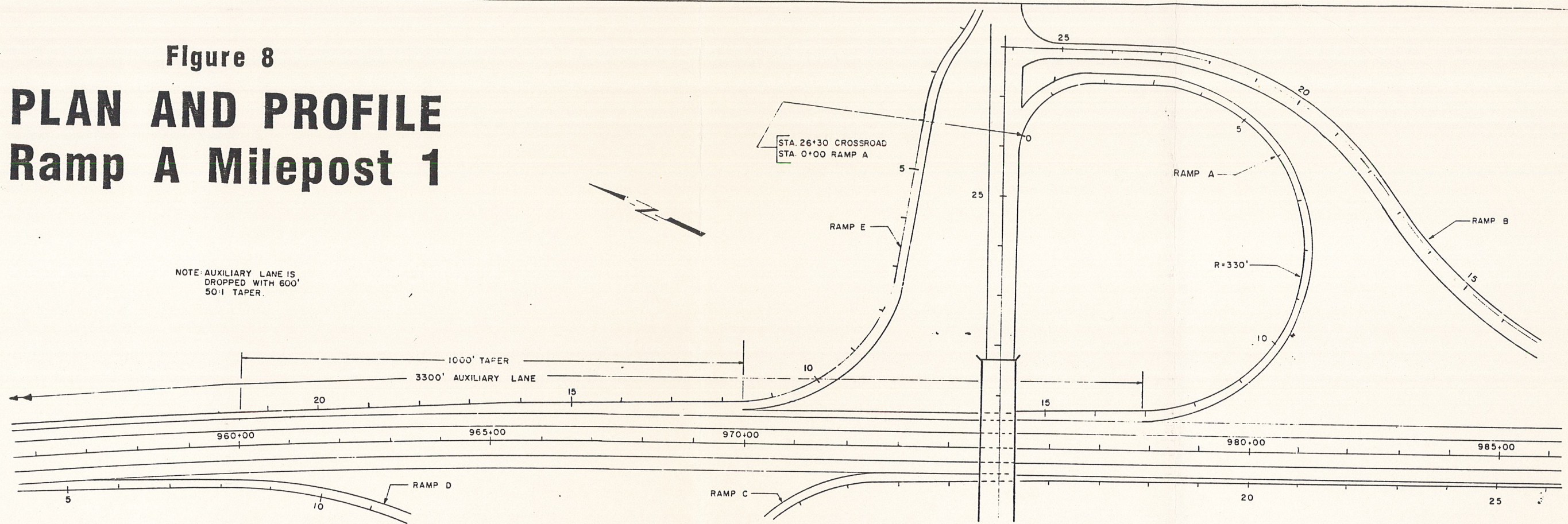

Figure 8

# PLAN AND PROFILE Ramp A Milepost 1

PLAN	DATE	BY	DATE
NO.			
NO.			

NOTE: AUXILIARY LANE IS DROPPED WITH 600' 50:1 TAPER.



PROFILE	DATE	BY	DATE
NO.			
NO.			

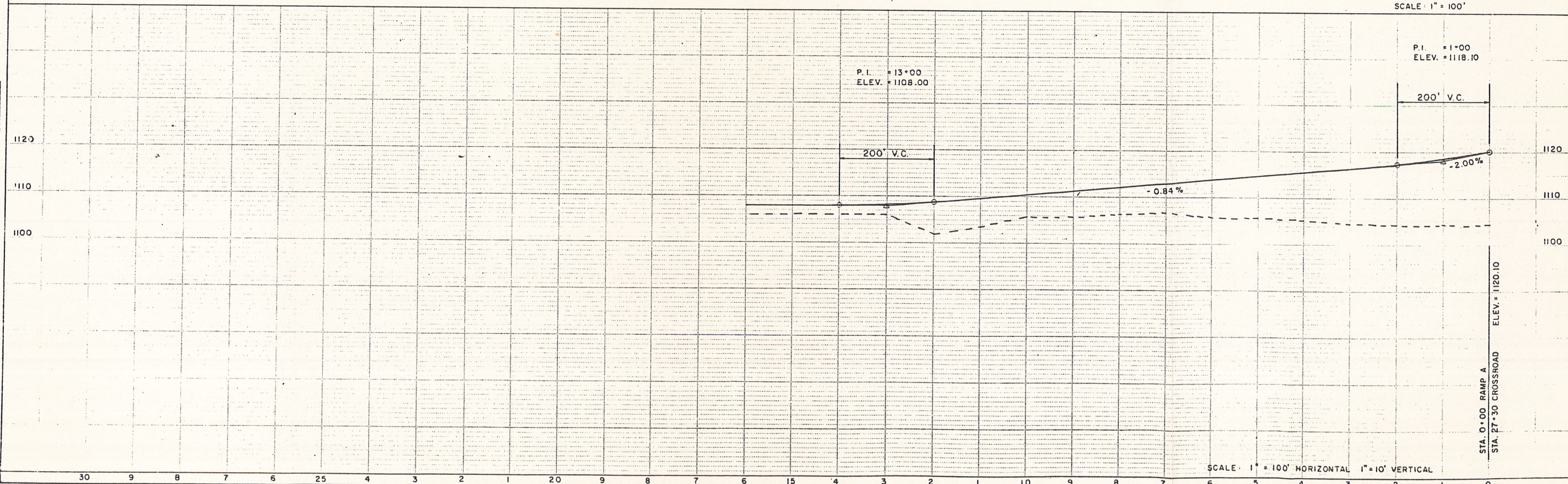
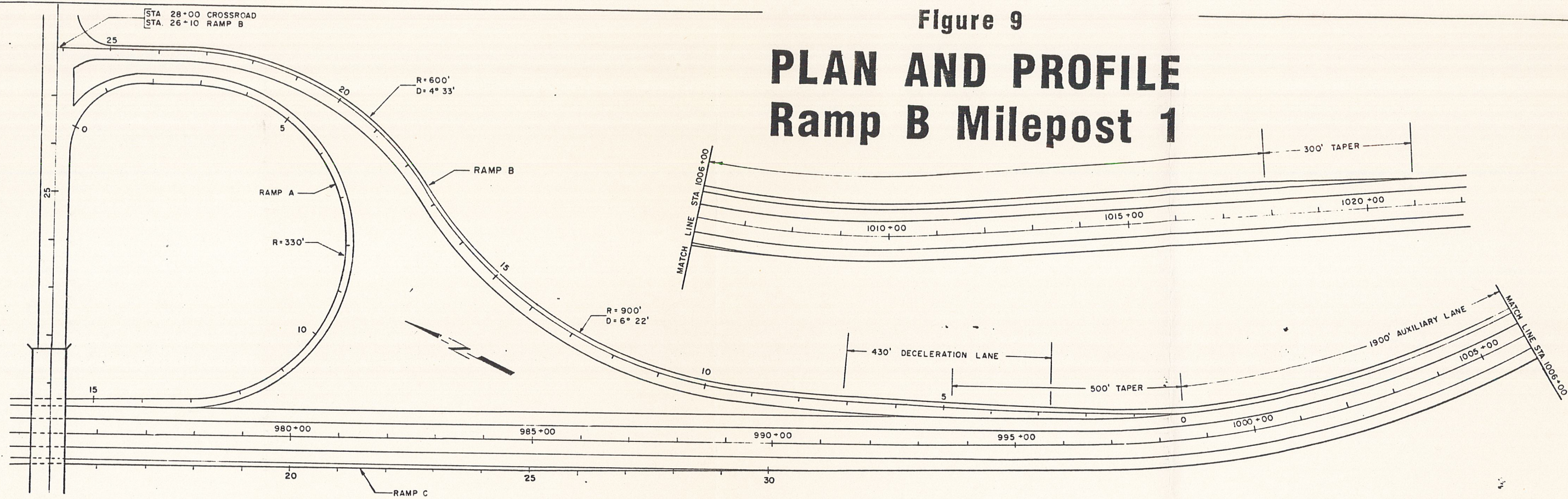



Figure 9

# PLAN AND PROFILE Ramp B Milepost 1

PLAN	DATE	
	BY	
	SCALE	
	NOTE BOOK NO.	
SURVEYED ALIGNED CHECKED DATE		



PROFILE	DATE	
	BY	
	SCALE	
	NOTE BOOK NO.	
SURVEYED GRADES CHECKED DATE		

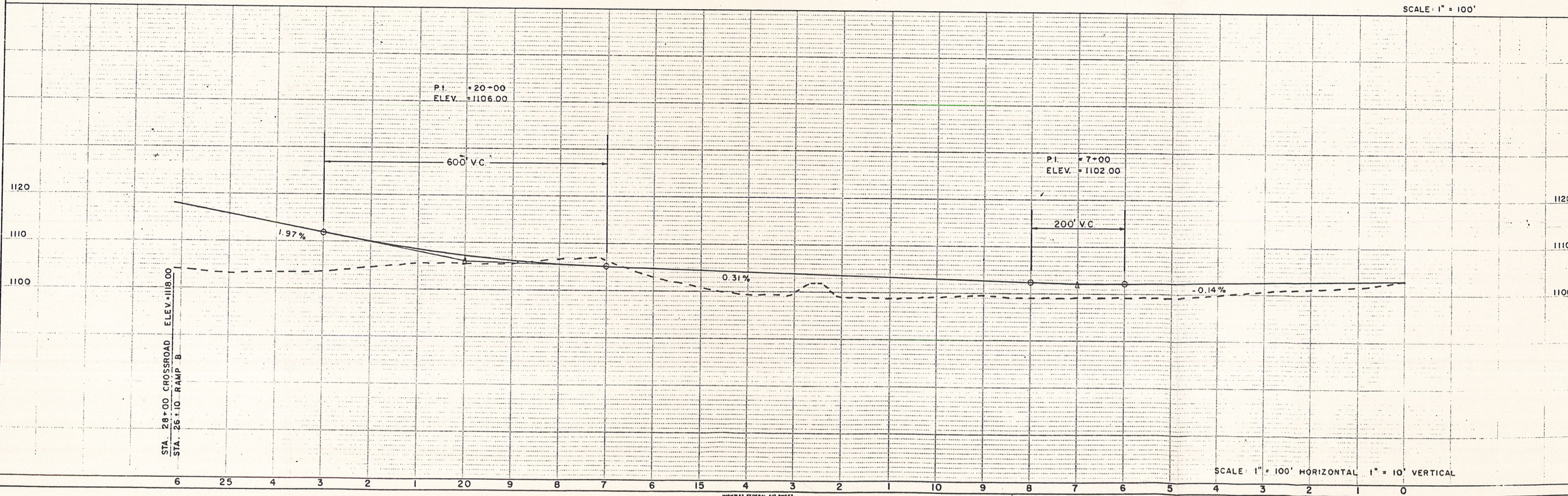



PLAN	DATE	
	BY	
PROFILE	DATE	
	BY	
SURVEYED BY		
CHECKED BY		
DESIGNED BY		
DRAWN BY		

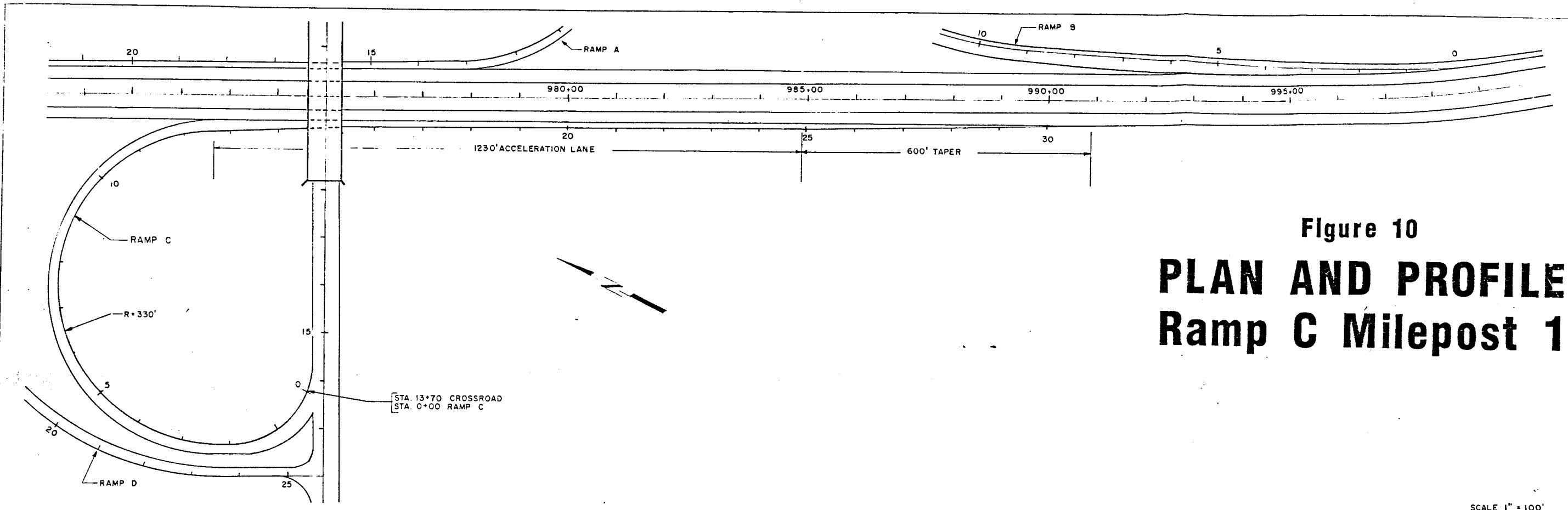
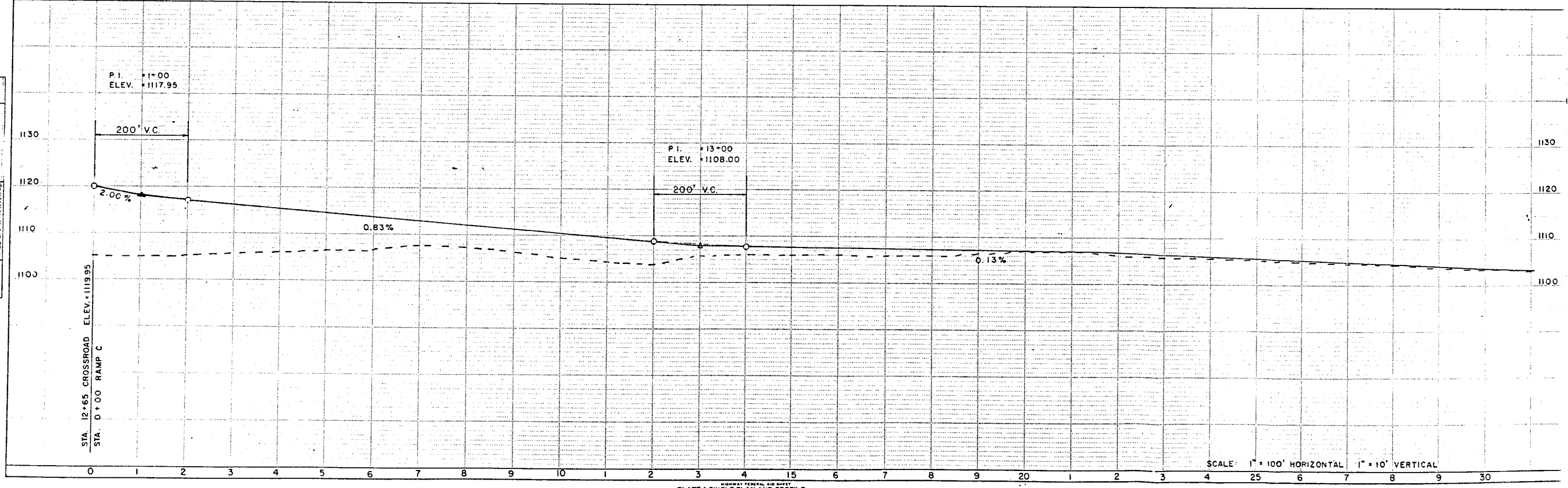

Figure 10  
**PLAN AND PROFILE**  
**Ramp C Milepost 1**

SCALE 1" = 100'

PROFILE	DATE	
	BY	
PLAN	DATE	
	BY	
SURVEYED BY		
CHECKED BY		
DESIGNED BY		
DRAWN BY		



SCALE: 1" = 100' HORIZONTAL 1" = 10' VERTICAL

PLAN	DATE	
	BY	
NOTE BOOK NO.	DESIGNED BY	
	CHECKED BY	
	DATE	

Figure 11  
**PLAN AND PROFILE**  
**Ramp D Milepost 1**

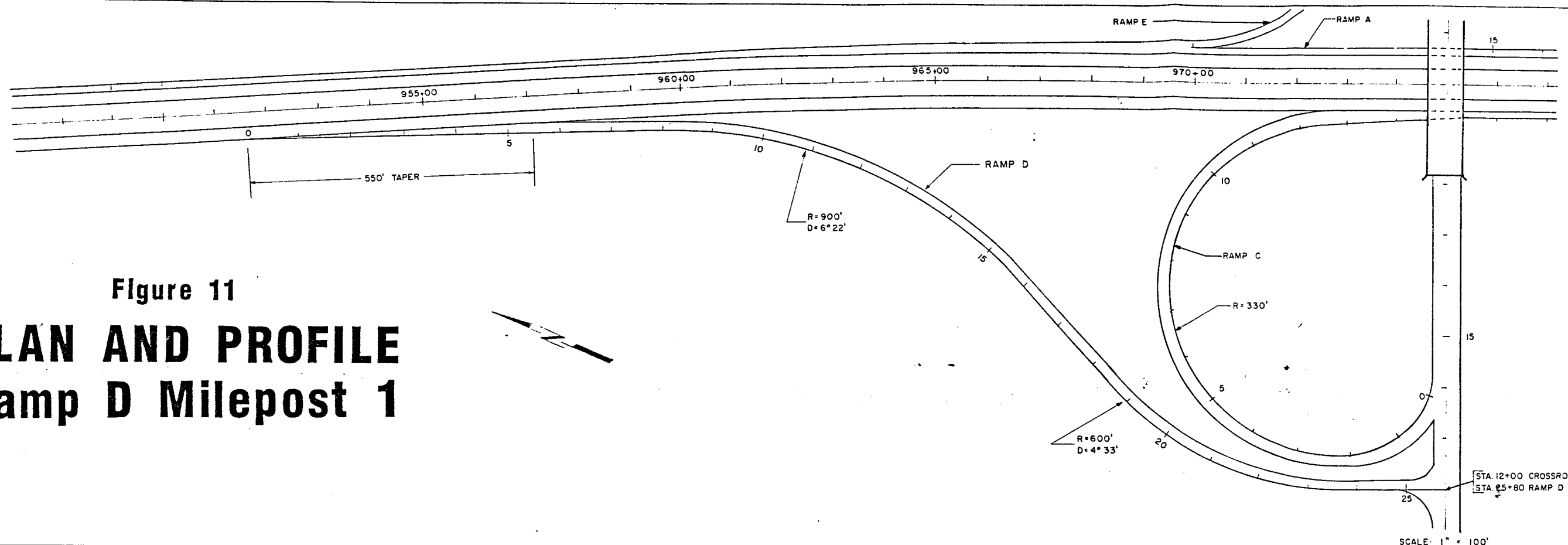

PROFILE	DATE	
	BY	
NOTE BOOK NO.	DESIGNED BY	
	CHECKED BY	
	DATE	

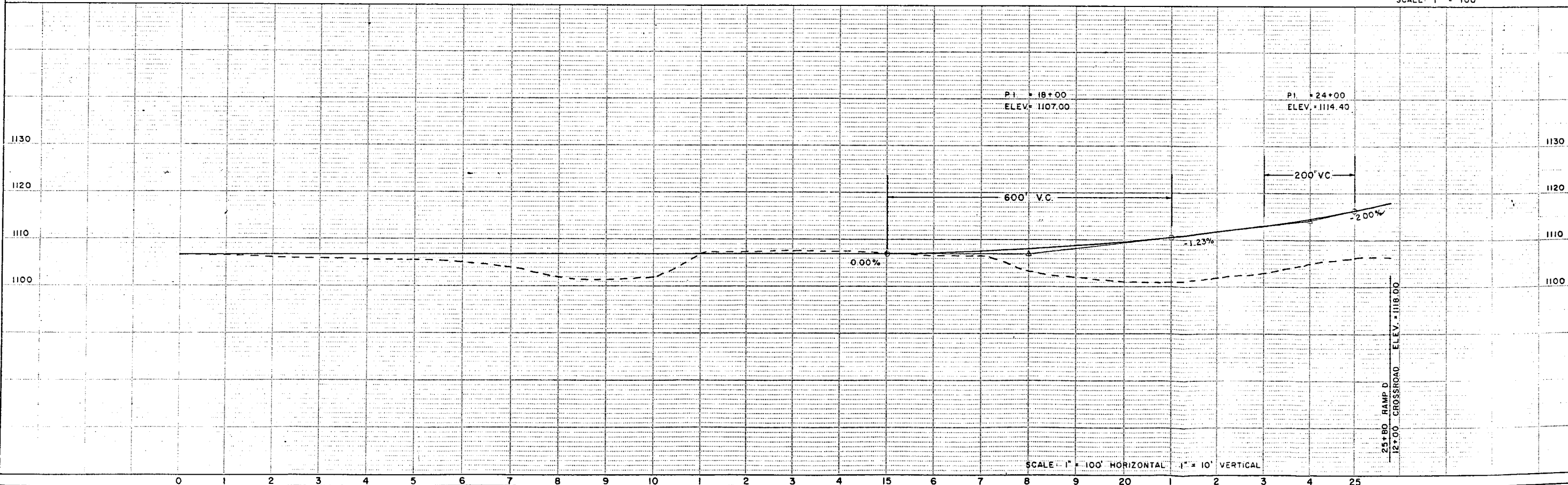



# Figure 12 PLAN AND PROFILE Ramp E Milepost 1

SCALE 1" = 100'

STA 30+15 CROSSROAD  
STA 0+00 RAMPE

R = 330'

R = 330'

25+00

RAMP E

5

R = 330'

10

15

3300' AUXILIARY LANE

1000' TAPER

20

15

550+00

955+00

960+00

965+00

PI = 11+00  
ELEV = 1107.0

PI = 3+00  
ELEV = 11045

400' VC

400' VC

0.11%

0.31%

2.35%

STA 0+00 RAMPE  
STA 30+15 CROSSROAD

SCALE 1" = 100' HORIZONTAL 1" = 10' VERTICAL

PLAN	DATE	
	NO. OF SHEETS	
PROFILE	DATE	
	NO. OF SHEETS	
SURVEYED GRADES CHECKED PLAN CHECKED DATE: 08/15/54		

PROFILE	DATE	
	NO. OF SHEETS	
SURVEYED GRADES CHECKED PLAN CHECKED DATE: 08/15/54		



# Figure 13 PLAN AND PROFILE Ramp F Milepost 1

PLAN	DATE	10/1/57
	BY	W.M. WOOD
PROFILE	DATE	10/1/57
	BY	W.M. WOOD
SURVEYED		
GRADED		
CONSTRUCTED		
NOTED		
NO		

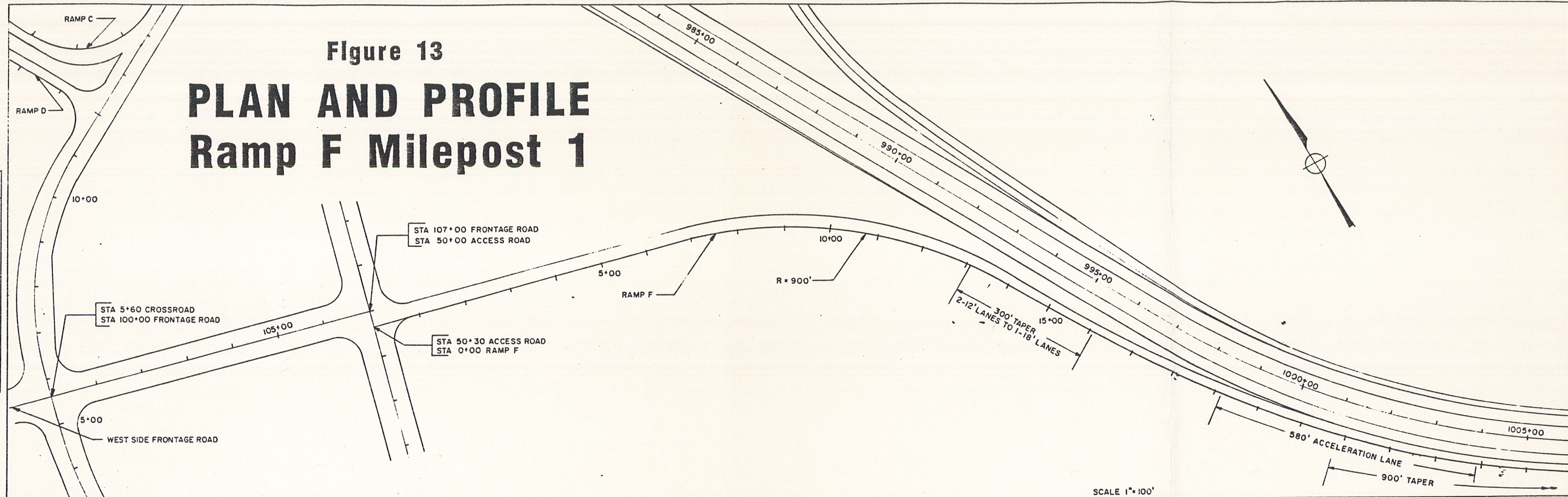

PROFILE	DATE	10/1/57
	BY	W.M. WOOD
SURVEYED	DATE	10/1/57
	BY	W.M. WOOD
GRADED		
CONSTRUCTED		
NOTED		
NO		

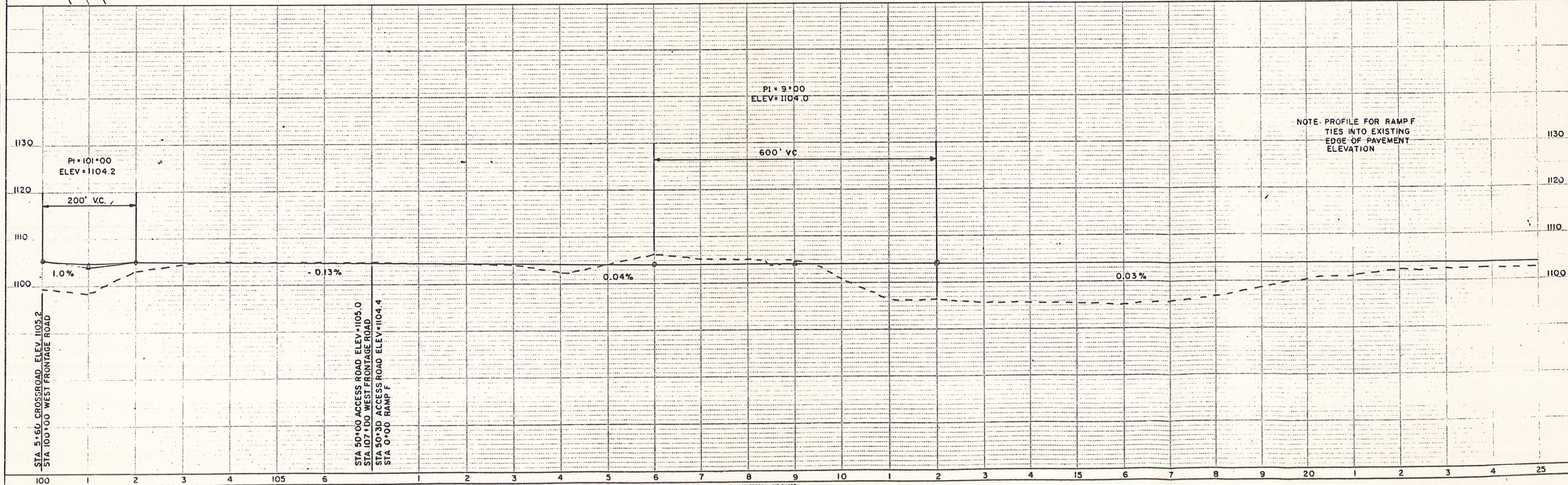
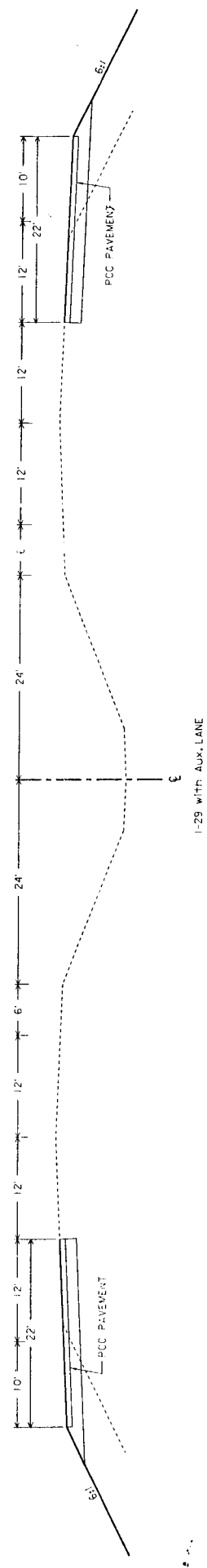
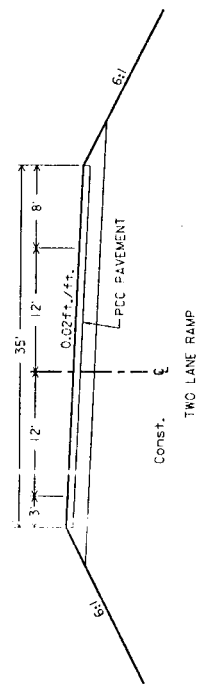
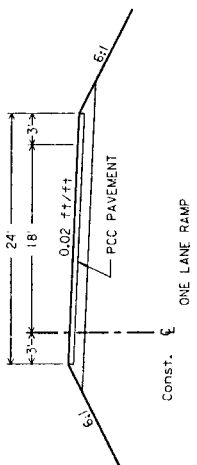
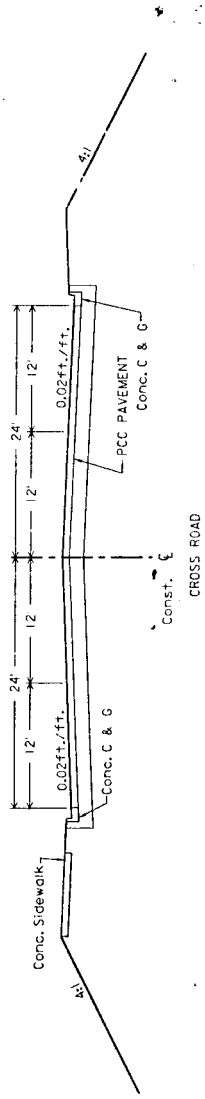



**Figure 14**

**TYPICAL GRADING SECTIONS**

FED. HWY. ADMIN. NO.	STATE OF	PROJECT	SHEET NO.	TOTAL SHEETS
B	S.D.	SAGECO		



\* LOAD RUMINOZ3W  
# G TYPCL  
PRT  
PFF

### Other Design Options Considered - Preferred Alternative (Alternative 1)

In addition to the modified diamond interchange, two other milepost one interchange designs were considered. One option was a two-lane crossroad diamond configuration consisting of a conventional diamond interchange with a two-lane roadway crossing the interstate. This option is not feasible because of the significant traffic volumes that the proposed development is expected to generate.

Another option which was considered and evaluated in detail was a five-lane crossroad diamond configuration. This option would have also consisted of a conventional diamond interchange, however, a five-lane cross section would be provided for the crossroad over the interchange. After careful evaluation, this option was judged to be less desirable than the modified diamond with respect to traffic operations, capacity, safety and aesthetics.

With respect to traffic capacity, it is projected that once the development is completed, there would be approximately 530 vehicles per hour (vph) during the p.m. peak hour from the east side of the development desiring to travel south and approximately 194 vph from the west side desiring to travel north. With the diamond interchange configuration, these vehicles would have to make a left turn across traffic on the crossroad and be stored on the bridge structure over the interstate.

Sight distance design criteria would have placed the diamond interchange ramps with a separation of approximately 850 feet. This would have allowed for 300 feet of storage for the left turn lanes in each direction. Normally the capacity of a left turn lane is reached when the peak hour volumes reach 300 vph. Unless dual left turn lanes are provided, vehicles waiting to turn left could end up disrupting thru traffic, left turning vehicles, or ramp



traffic on the opposite side of the interchange. In addition, provision of dual left turn lanes with this configuration would require construction of a wider more costly bridge and the possibility of disruption to thru or turning traffic from left-turn movements is still present.

With the modified diamond interchange, there would be no left turning vehicles on the crossroad to disrupt ramp or thru traffic, resulting in an improved level of service. The modified diamond interchange is also a safer configuration than the standard diamond interchange because of the elimination of conflicts between left-turn movements and the thru or ramp traffic.

#### Interchange Signing

The interchange signing for the preferred alternative will be done for the convenience of the travelling public and in accordance with the Manual on Uniform Traffic Control Devices, Federal Highway Administration, 1986, and applicable South Dakota Department of Transportation regulations.

## TRAFFIC ASSUMPTIONS AND ASSIGNMENTS

### Traffic Model

The Dakota Dunes peak hour traffic forecasts were produced using the TMODEL 2 transportation model. This software was developed by Professional Solutions Inc. which is a division of Metro Transportation Group Inc., Bloomingdale, Illinois. TMODEL 2 is a gravity model which distributes trips to various zones based upon land use, travel time, and distance. The model can use either iterative or incremental network loading. Trip distribution is recalculated for each increment using conventional gravity model programs. Trip generation rates for the analysis were derived from the 1987 ITE Trip Generation Manual and NCHRP 187, "Quick-Response Urban Travel Estimation Techniques and Transferable Parameters User's Guide".

### Model Parameters

Land uses and the development schedule for the Dakota Dunes site were furnished by the developers. Off-site land use assumptions were developed jointly between the South Dakota Department of Transportation, the Siouxland Interstate Metropolitan Planning Council, and representatives from the Sioux City, Iowa planning staff.

At full build out in 2008, approximately 1,000 employees of Dakota Dunes will live in the projected 1,165 housing units developed on-site. Since the Dakota Dunes project is job intensive (more jobs than dwelling units), the remaining 5,000 employees would live outside of the project area, yet near enough for easy commuting. Therefore, for the purpose of traffic forecasting, some of the land on the west side of I-29 between mileposts one and two is assumed to develop into a residential area. The remaining employee trips

would be generated from the towns north and south of the project site, with the majority of these trips being generated from Sioux City, Iowa.

Using this information and the existing highway network, a roadway system was developed in the link and node format for the model. For each of the existing links and nodes in the network, a number of criteria were assigned for a "with interchange" and "no interchange" scenario at milepost one. These included 1 or 2 way designation, number of lanes, directional capacity, length, design speed, and existing peak hour traffic.

### Zone Assignment

Dakota Dunes and the surrounding area was then divided into 9 zones to assign land uses to drive the model. For each of the zones, the number of Single Family Dwelling Units (SFDU), Multiple Family Dwelling Units (MFDU), retail employees, and non-retail employees were loaded into the model. In TMODEL 2, the dwelling units are considered trip producers and the employment areas are considered trip attractors. In applying a daily trip generation rate to the collected land use data, a SFDU was assigned a daily trip generation rate of 10 and the MFDU was assigned 6 trips per day. The number of retail and non-retail trips per employee were computed from the "National Cooperative Highway Research Program 187 User's Guide" for each of the designated land uses.

The nine traffic analysis zones are shown in Figure 15 and described below.

- Zone 1 This is an external zone which represents traffic on I-29 which is generated from areas south of the Dakota Dunes project area.
- Zone 2 This zone is within the Dakota Dunes development on the east side of I-29. The land use in this zone includes a 200 room hotel, a 9 hole golf course, and corporate office space.
- Zone 3 This zone is within the Dakota Dunes development on the east side of I-29. The land use in this zone includes a research center and corporate office space.
- Zone 4 This zone includes North Sioux City, South Dakota that lies on the east side of I-29.
- Zone 5 This is an external zone which represents traffic on I-29 generated from areas north of the Dakota Dunes project area.
- Zone 6 This zone includes North Sioux City, South Dakota that lies on the west side of I-29 and Sodrac Park dog racing track.
- Zone 7 This zone includes Riverland Estates development, as well as currently sparsely developed agricultural land assumed to become residential.
- Zone 8 This zone is within the Dakota Dunes development on the west side of I-29. The land use in this zone includes light industry, apartments, and a shopping center.
- Zone 9 This zone is within the Dakota Dunes development on the west side of I-29. The land use in this zone includes an 18 hole golf course, apartments, a school, condominiums, a marina, a housing development, and a shopping center.

### Model Analysis

Simulation runs were then performed for four different scenarios, AM and PM peak hours with an interchange at milepost one and AM and PM with no interchange at milepost one. These scenarios produced peak hour traffic volumes that are presented in the following section of this report.

FIGURE 15

# TRAFFIC ANALYSIS ZONES

## DAKOTA DUNES

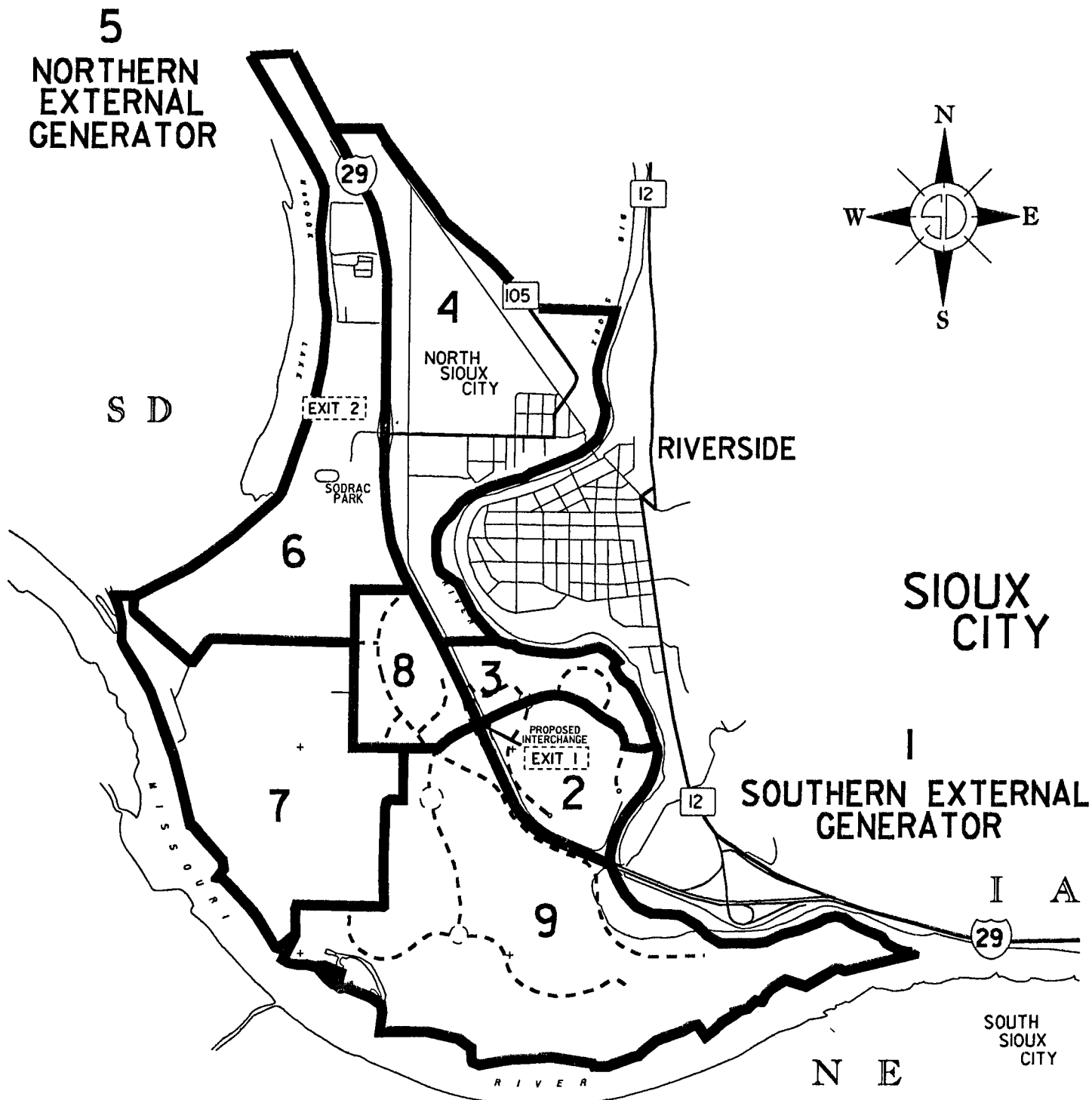

## EXISTING TRAFFIC AND PROJECTED TRAFFIC IMPACTS

Average Daily Traffic, Design Hour Volumes, AM and PM Peak Hour traffic projections, as developed from TMODEL 2, and Level of Service designations, as calculated from the 1985 Highway Capacity Manual software, are graphically displayed in the following figures. The detailed level of service worksheets produced by the software are contained in the appendix to this study.

Figures 16 through 18 show the existing conditions on I-29 at milepost one.

- Figure 16: Existing ADT at milepost two.
- Figure 17: Existing Peak Hour traffic at milepost two.
- Figure 18: Existing Level of Service at milepost two.

Although the existing levels of service for the interchange at milepost two are A's and B's, as the development grows, the operation of the existing interchange at milepost two will deteriorate to a level of service D during the third, five-year period of development. However, reconstruction of the only access to the development will be extremely difficult with the high traffic volumes expected. The South Dakota Department of Transportation recommends that milepost two be reconstructed soon after the development begins to avoid traffic management problems during construction if only milepost two is to be used.

FIGURE 16

# EXISTING INTERSTATE SYSTEM 1989 AVERAGE DAILY TRAFFIC AT M.P. 2

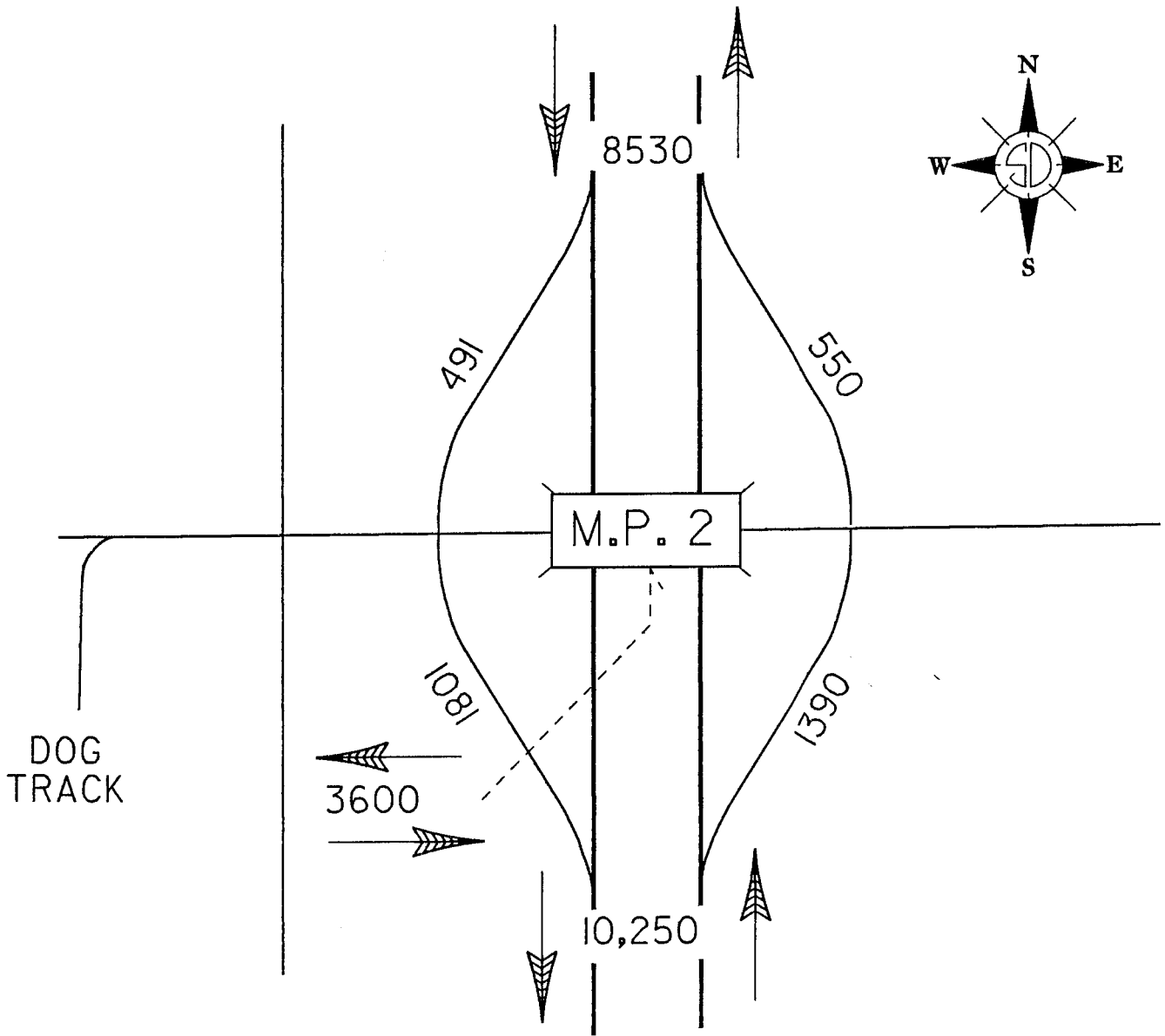

FIGURE 17

# EXISTING INTERSTATE SYSTEM 1989 PEAK HOUR TRAFFIC AT M.P. 2

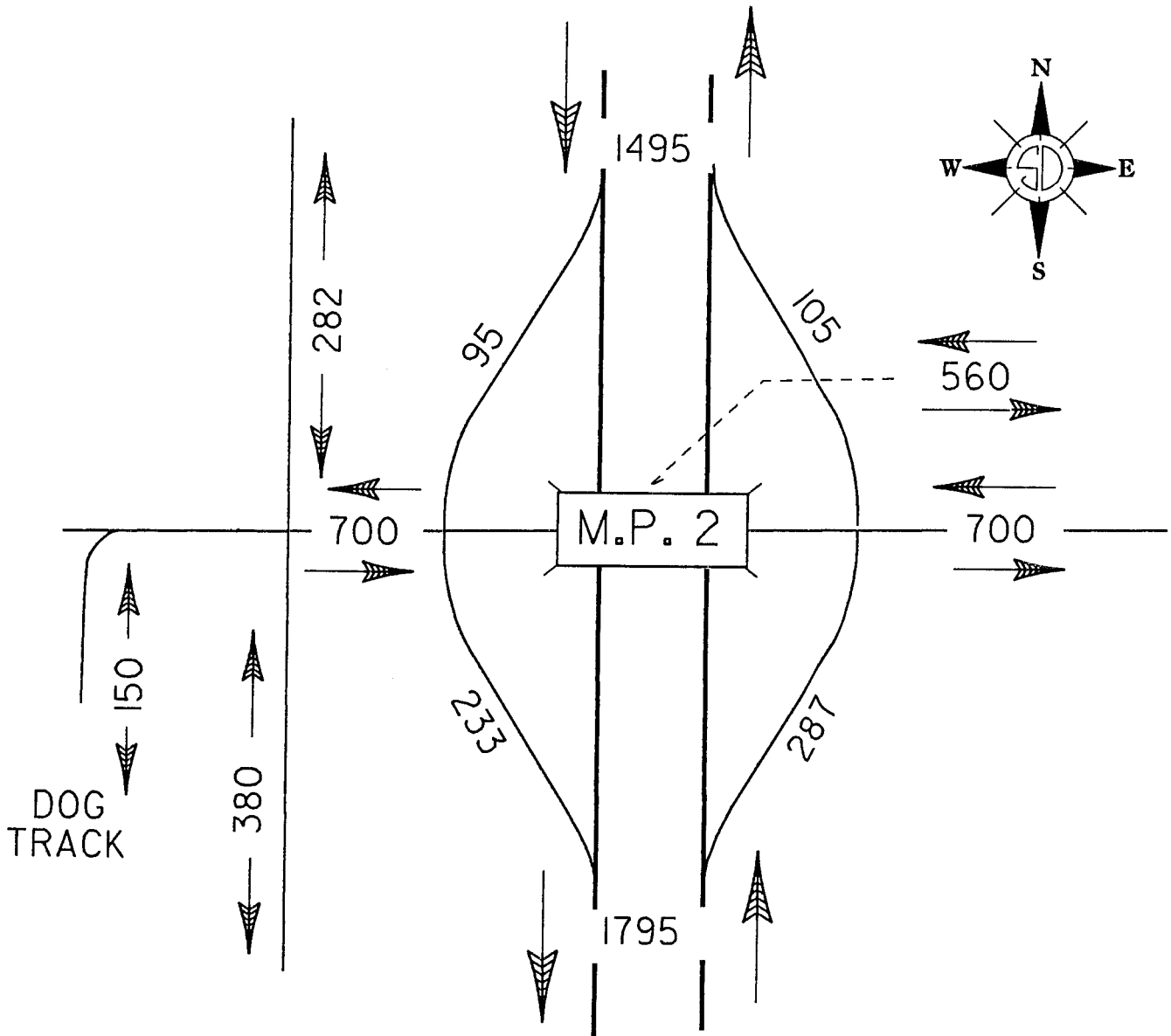
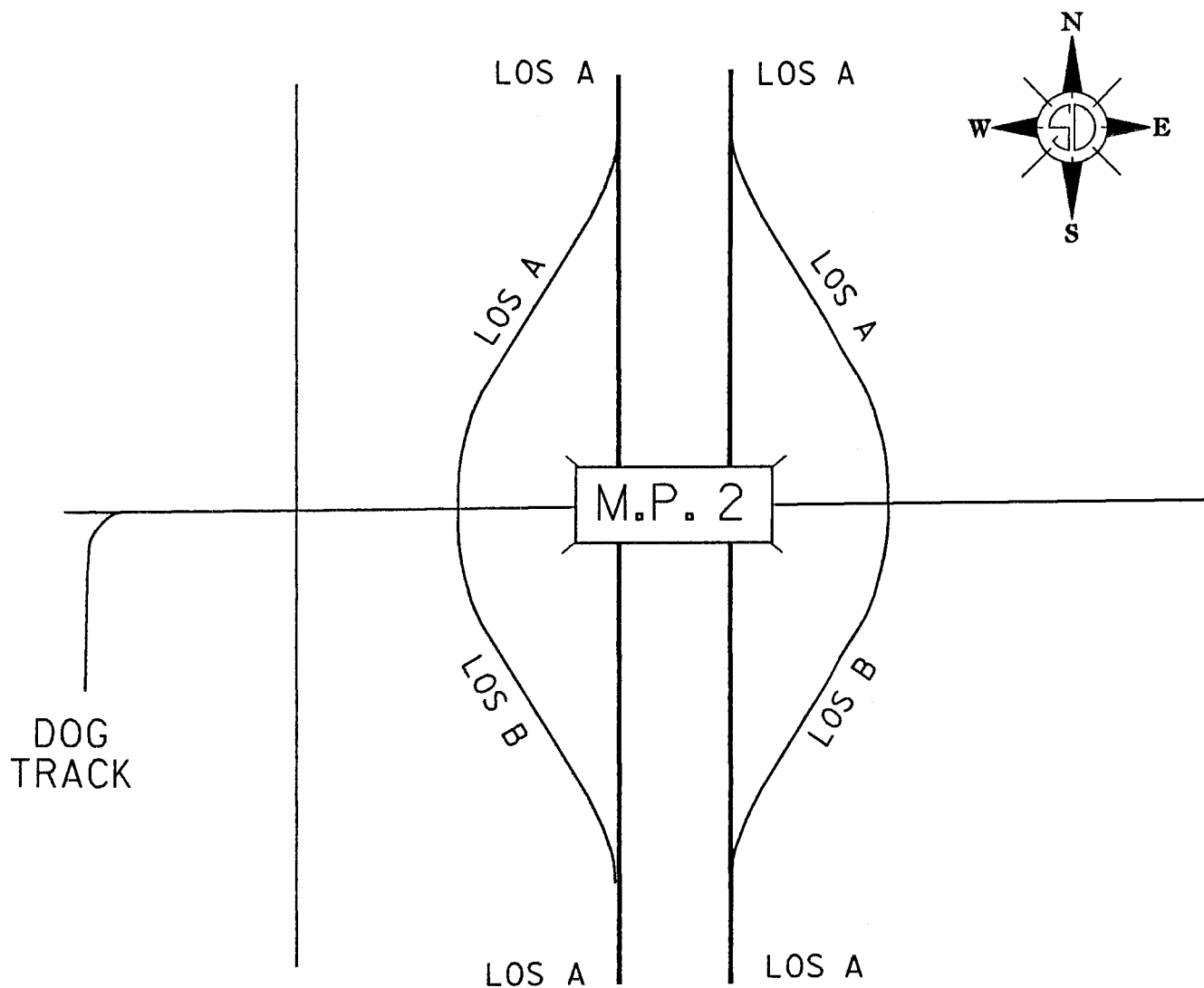



FIGURE 18

# EXISTING INTERSTATE SYSTEM 1989 PEAK HOUR LEVEL OF SERVICE AT M.P. 2



Figures 19 through 22 show Alternative I projections on I-29 at milepost one and milepost two at full build out in 2008.

Figure 19: Alternative I, 20 year projected ADT.  
Figure 20: Alternative I, AM Peak Hour Traffic and LOS.  
Figure 21: Alternative I, PM Peak Hour Traffic and LOS.  
Figure 22: Alternative I, Design Hour Volumes.

The traffic analysis also revealed that the number of a.m. peak hour trips from the external Zone 1 (Sioux City) to the development increased by 268 trips when a new interchange was added at milepost one. This means that 2,680 more trips a day or 978,000 trips a year would come from Sioux City to the development, resulting in a significant positive economic impact.

The level of service provided by both alternative one and alternative two are acceptable levels as determined by the Department of Transportation. However, the benefits to the traveling public are far better served by the preferred alternative, as is shown in the benefit cost analysis which follows this section.

#### Intersection Traffic and Level of Service Analysis

An intersection traffic and level of service (LOS) analysis was done at milepost one for the on-off ramp intersections as well as the east and west side frontage road intersections for each designed considered using TRANSYT-7F modeling software. All four intersections were modelled collectively as a network. Due to large left turn volumes during the PM peak hour, dual left turn lanes were modelled to keep delays within acceptable range for the southbound left turn movements at the west side frontage road intersection and the west bound left turn movements at the west side ramp intersection for

FIGURE 19

# ALTERNATIVE I

(PREFERRED ALTERNATIVE)

## INTERCHANGES at M.P. 1 and M.P. 2 20 YEAR PROJECTED ADT ( FULL BUILD OUT )

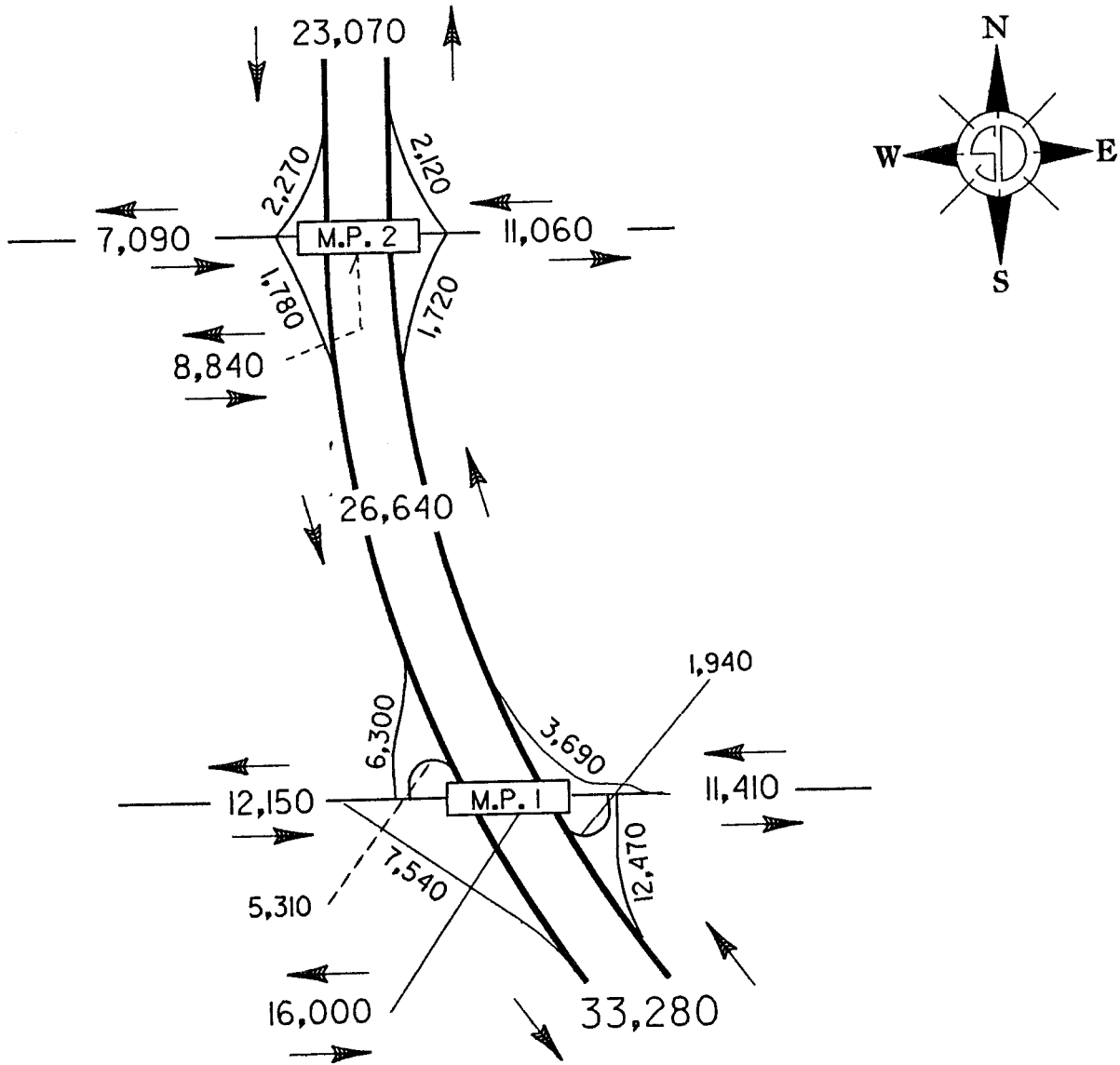

FIGURE 20

# ALTERNATIVE I

(PREFERRED ALTERNATIVE)

## INTERCHANGES at M.P. 1 and M.P. 2 20 YEAR PROJECTED ( FULL BUILD OUT )

AM PEAK HOUR TRAFFIC AND LEVEL OF SERVICE

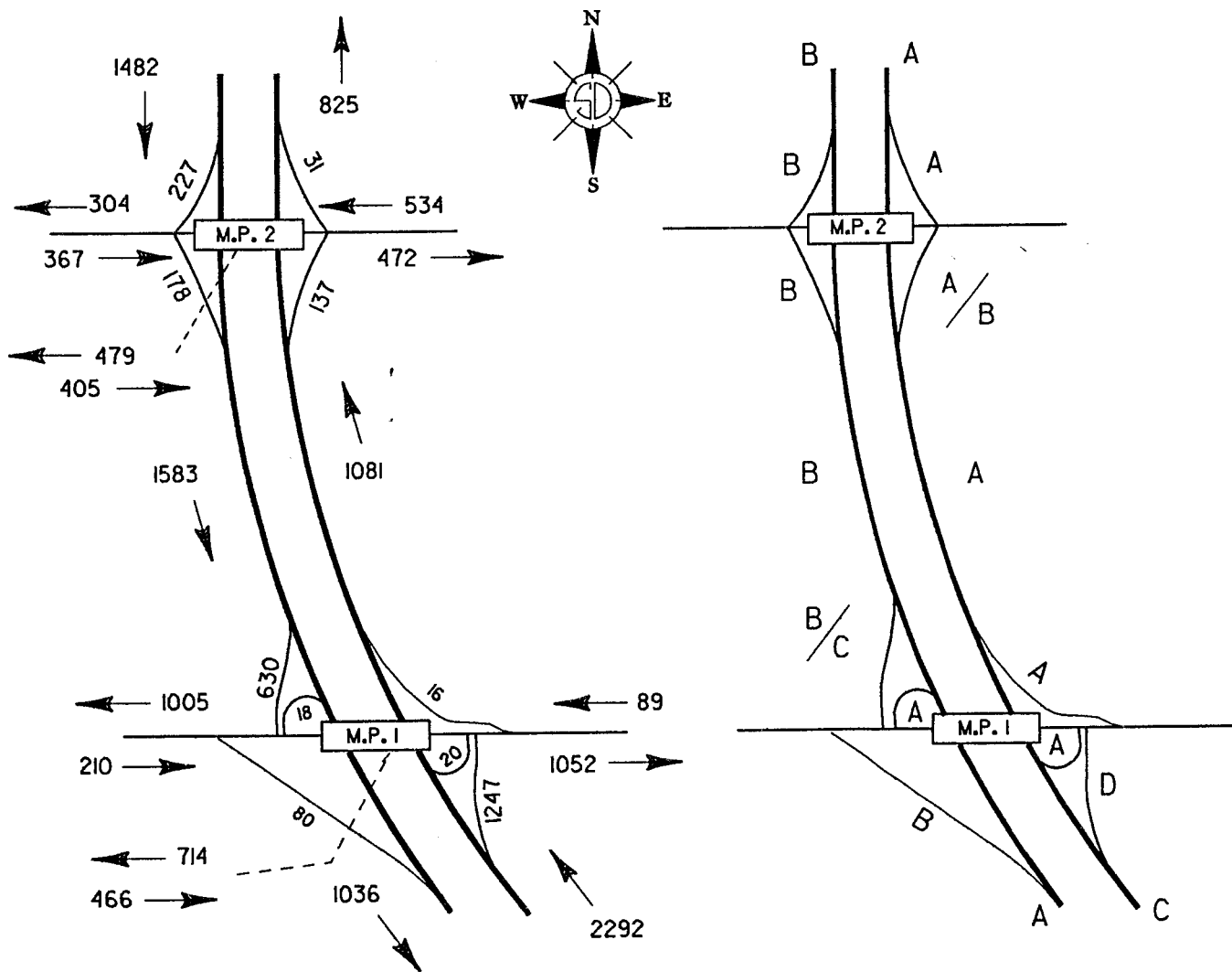

FIGURE 21

# ALTERNATIVE I

(PREFERRED ALTERNATIVE)

## INTERCHANGES at M.P. 1 and M.P. 2 20 YEAR PROJECTED ( FULL BUILD OUT )

PM PEAK HOUR TRAFFIC AND LEVEL OF SERVICE

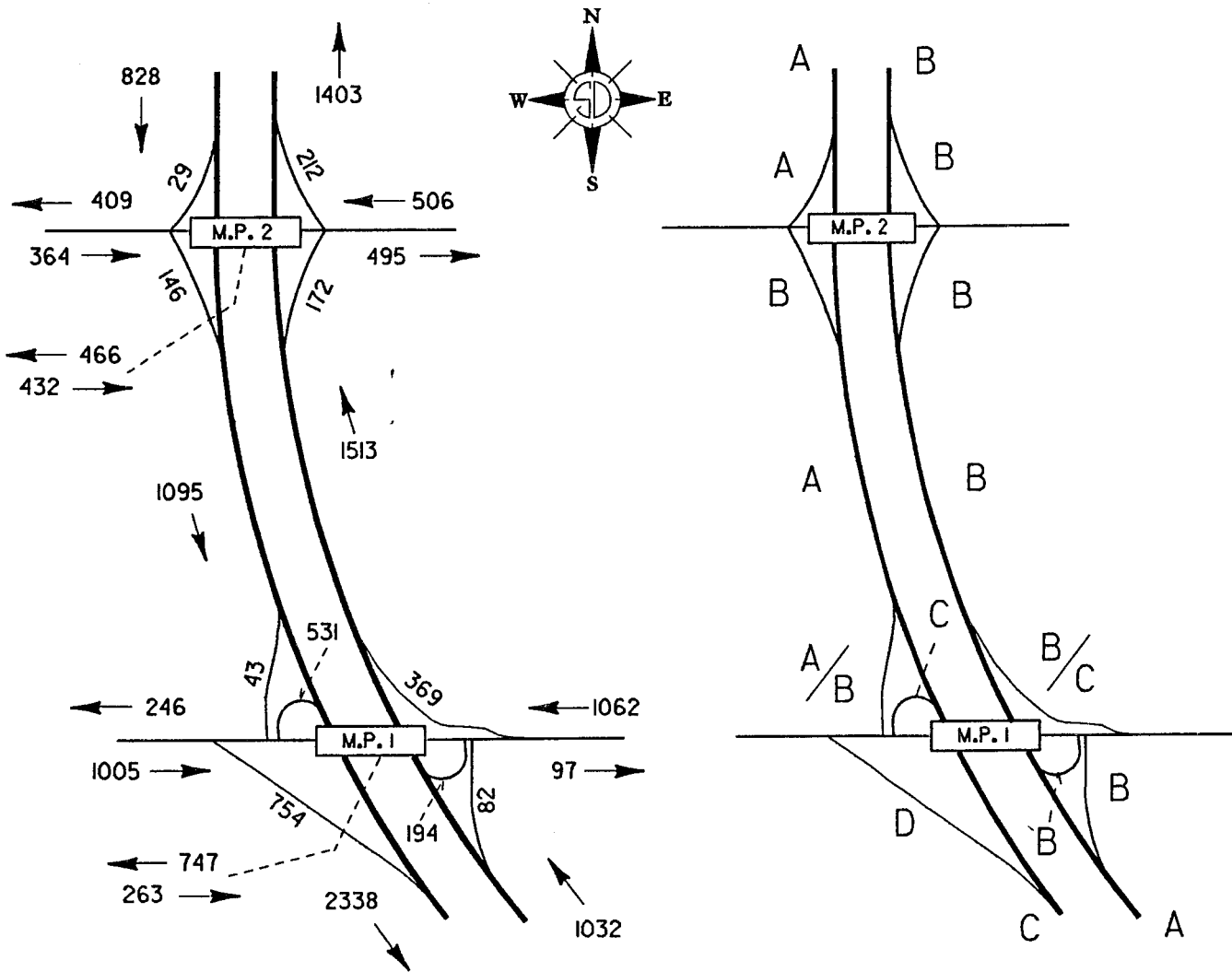
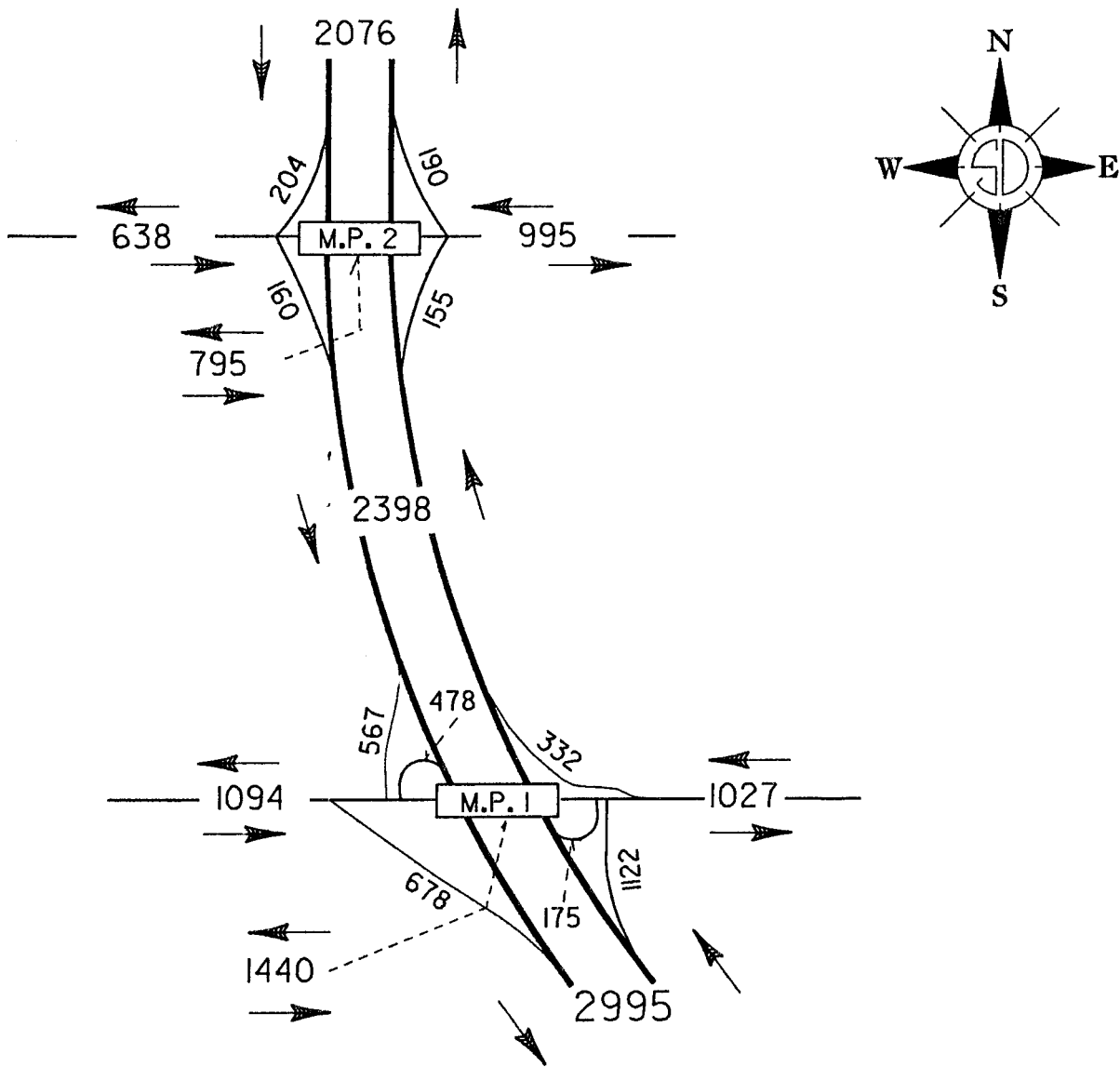

FIGURE 22

# ALTERNATIVE I

(PREFERRED ALTERNATIVE)

## INTERCHANGES at M.P. 1 and M.P. 2 DESIGN HOUR VOLUMES ( FULL BUILD OUT )



diamond interchange; and the northbound left turn movements at the east side frontage road intersection for both the diamond interchange and the modified diamond interchange. The optimum cycle length for the AM peak hour was 80 seconds and 70 seconds for the PM peak hour. The table contained in Figure 23 compares the level of service for each interchange design. Figures 24 and 25 graphically show the traffic movements and LOS of each intersection for the modified diamond interchange design. The numbers and letters in parentheses indicate the traffic and LOS for the PM peak hour. Although some of the turning movements have a level of service of "D", the low volume of traffic performing these movements would experience little delay. The traffic movements and LOS for each intersection for the diamond interchange design are shown in Figure 26.

#### Level of Service Analysis of Interchange at Milepost 2 with an Interchange at Milepost 1

An analysis of the traffic at the interchange at milepost 2 was done to determine the impact of the development and the level of service the existing interchange would provide if an interchange is built at milepost one. The analysis was done using three scenarios, (1) stop signs controlling all minor street approaches both the ramps and frontage road intersections, (2) for both the ramps and frontage road intersections fully signalized, and (3) fully signalized intersections for the ramp intersections and stop signs for the minor street access at the frontage road intersections.

The findings indicate that stop signs at both the ramps and frontage road intersections would result in level of service D and E for the northbound off ramp, and E and F for the southbound off ramp which may result in traffic

Figure 23

Level of Service Comparison of Proposed Interchange Designs

OPTION	INTERSECTION	LEVELS OF SERVICE									
		WESTBOUND		EASTBOUND		NORTHBOUND		SOUTHBOUND		OVERALL	
		AM	PM	AM	PM	AM	PM	AM	PM	AM	PM
M D O I D A I M F O I N E D D	WEST SIDE FRONTAGE ROAD	B	D	B	D	D	C	D	C	B	C
	RAMPS C & D	B	A	B	A	NA	NA	C	C	B	A
	RAMPS A & B	C	A	D	A	B	C	NA	NA	B	A
	EAST SIDE FRONTAGE ROAD	B	D	B	C	D	C	D	D	B	D
	RAMP F & ACCESS ROAD	D	C	D	C	NA	NA	B	B	B	B
D I A M O N D	WEST SIDE FRONTAGE ROAD	B	C	B	D	C	C	C	C	B	C
	RAMPS C & D	B	D	B	B	NA	NA	C	C	B	C
	RAMPS A & B	D	B	D	B	B	C	NA	NA	C	B
	EAST SIDE FRONTAGE ROAD	C	D	B	C	C	D	D	D	B	D



FIGURE 24

# INTERSECTION ANALYSIS AT MILEPOST 1

MODIFIED DIAMOND INTERCHANGE WITH FREE-FLOW RAMP  
IN SOUTHWEST QUADRANT

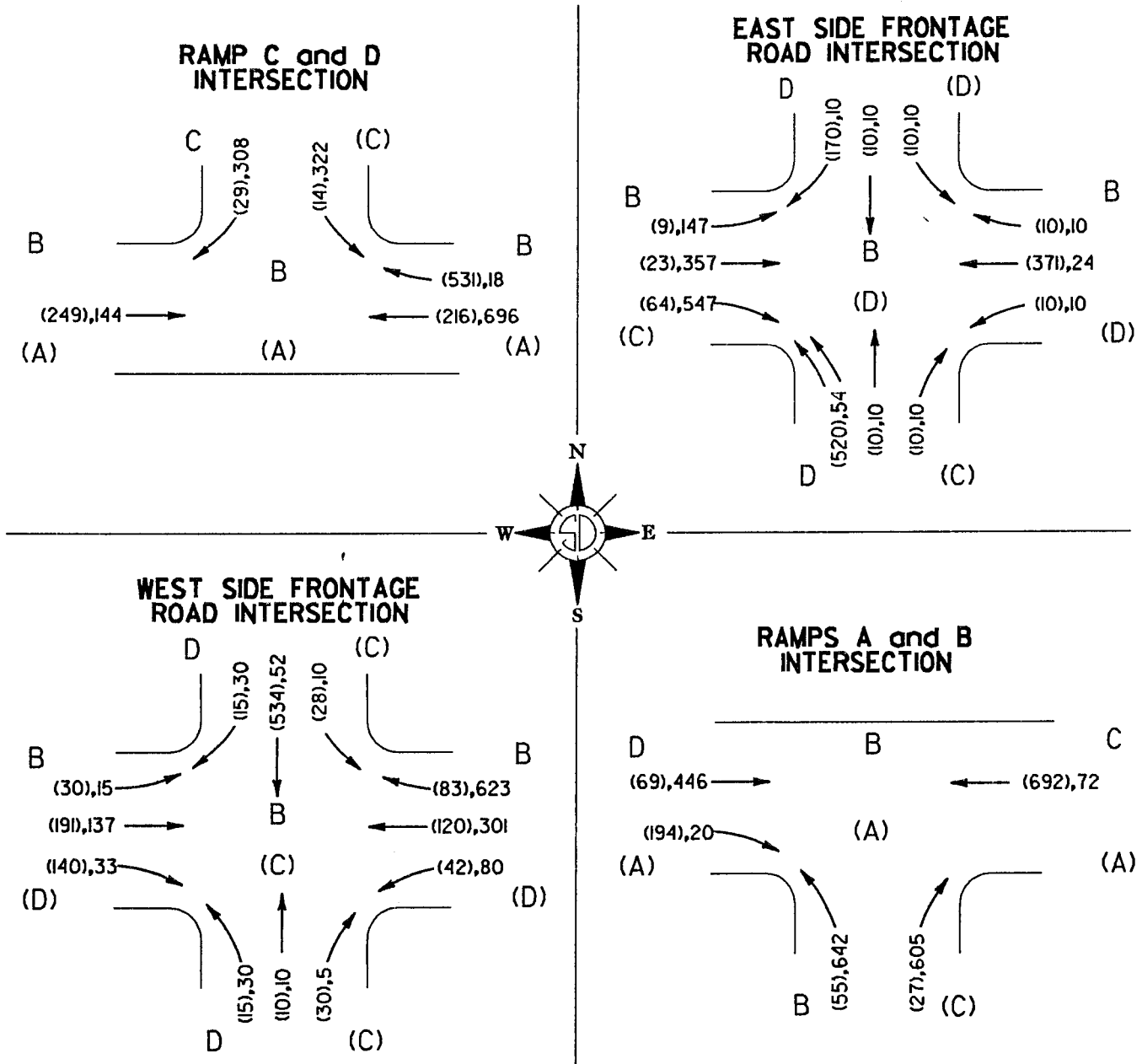

NOTE: NUMBERS IN PARENTHESES INDICATE P.M. PEAK HOUR MOVEMENTS. NO PARENTHESES INDICATE A.M. PEAK HOUR MOVEMENTS.

FIGURE 25

# INTERSECTION ANALYSIS AT MILEPOST 1

MODIFIED DIAMOND INTERCHANGE WITH FREE-FLOW RAMP  
IN SOUTHWEST QUADRANT

## RAMP F and DAKOTA DUNES ACCESS ROAD INTERSECTION

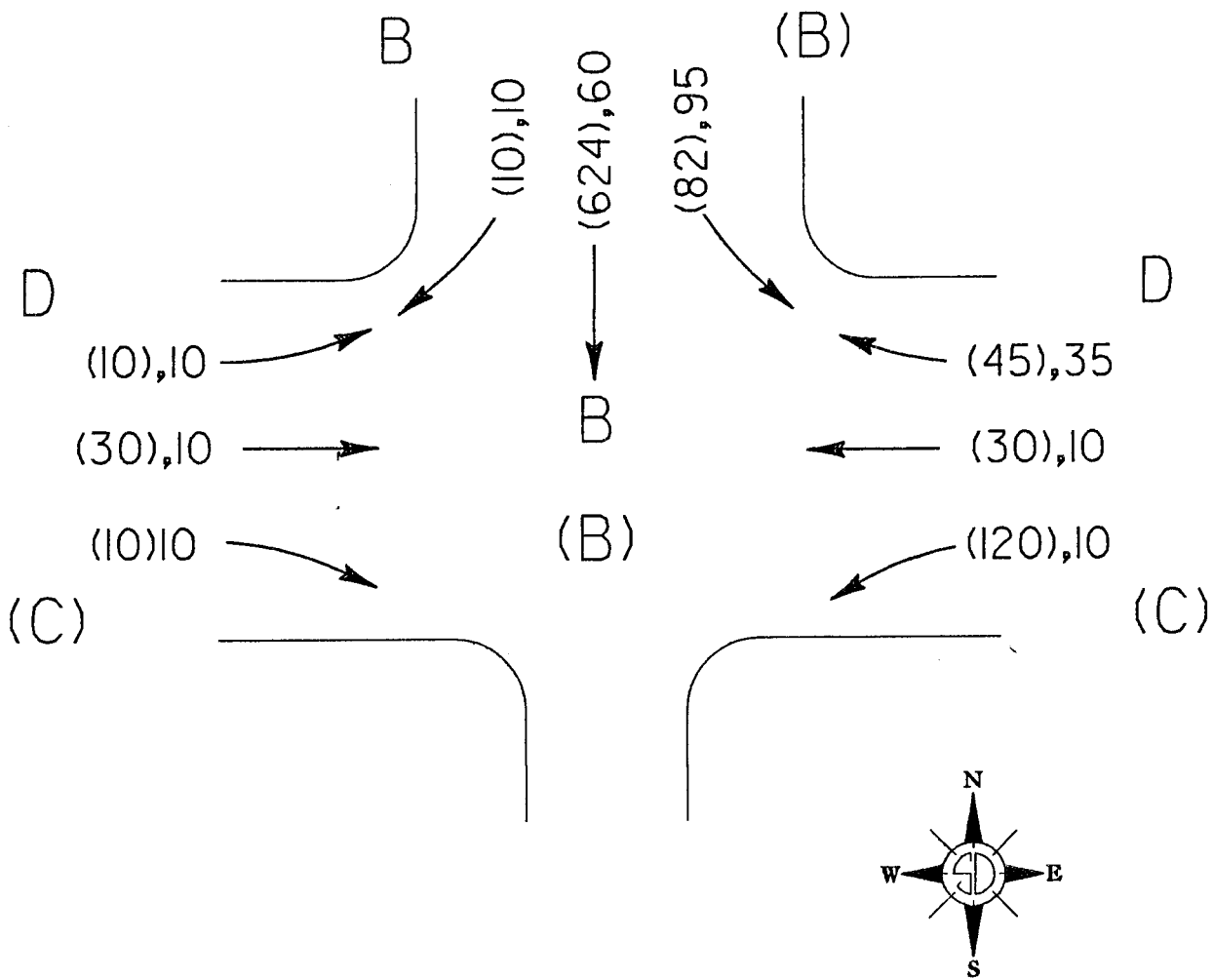

NOTE: NUMBERS IN PARENTHESES INDICATE P.M. PEAK HOUR MOVEMENTS. NO PARENTHESES INDICATE A.M. PEAK HOUR MOVEMENTS.

FIGURE 26

# INTERSECTION ANALYSIS AT MILEPOST 1

## DIAMOND INTERCHANGE

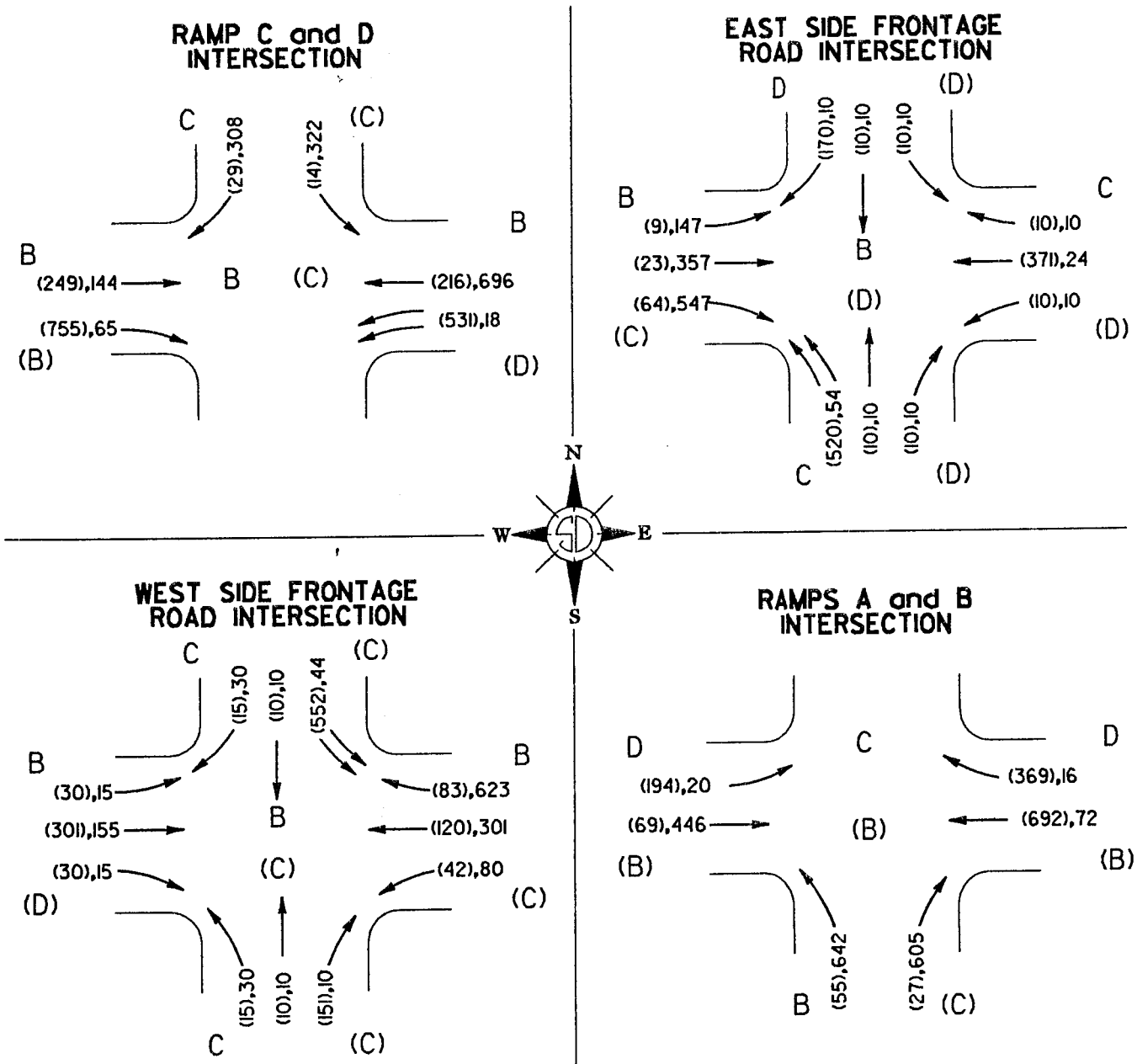

NOTE: NUMBERS IN PARENTHESES INDICATE P.M. PEAK HOUR MOVEMENTS. NO PARENTHESES INDICATE A.M. PEAK HOUR MOVEMENTS.

being backed-up onto the interstate. Fully signalized intersections for both the ramp and frontage road intersections is found to be unnecessary due to the low volume of traffic on the frontage road. The analysis indicates that the ramp intersections with the crossroad should be signalized to minimize ramp traffic delay and prevent ramp traffic from backing up onto the interstate. The frontage roads can be easily controlled by stop signs. While it appears that some of the frontage road intersections will have a poor level of service, the volumes for those movements are small and delays will be minimal. If the delays at these intersections increase significantly, traffic signals can be installed in the future. Figure 27 graphically shows the turning movements and level of service achieved with a combination of traffic signals and stop signs controlling traffic movement.

#### Level of Service Analysis of Interchange at Milepost 2 without an Interchange at Milepost 1

A level of service analysis was also done to determine what impact, if any, the proposed development would have on the level of service provided by the existing structures at milepost two, if no interchange was constructed at milepost one. A four-lane cross section with a separate thru and left turn lane provided at all intersections was used in the analysis. As indicated in Figure 28, the level of service for the A.M. peak hour volumes is acceptable, however, the P.M. peak hour volumes result in level of service "F" for several movements.

FIGURE 27

# INTERSECTION ANALYSIS AT MILEPOST 2

WITH INTERCHANGE AT MILEPOST 1

TRAFFIC SIGNALS AT RAMP INTERSECTIONS  
STOP SIGNS AT FRONTAGE ROAD INTERSECTIONS

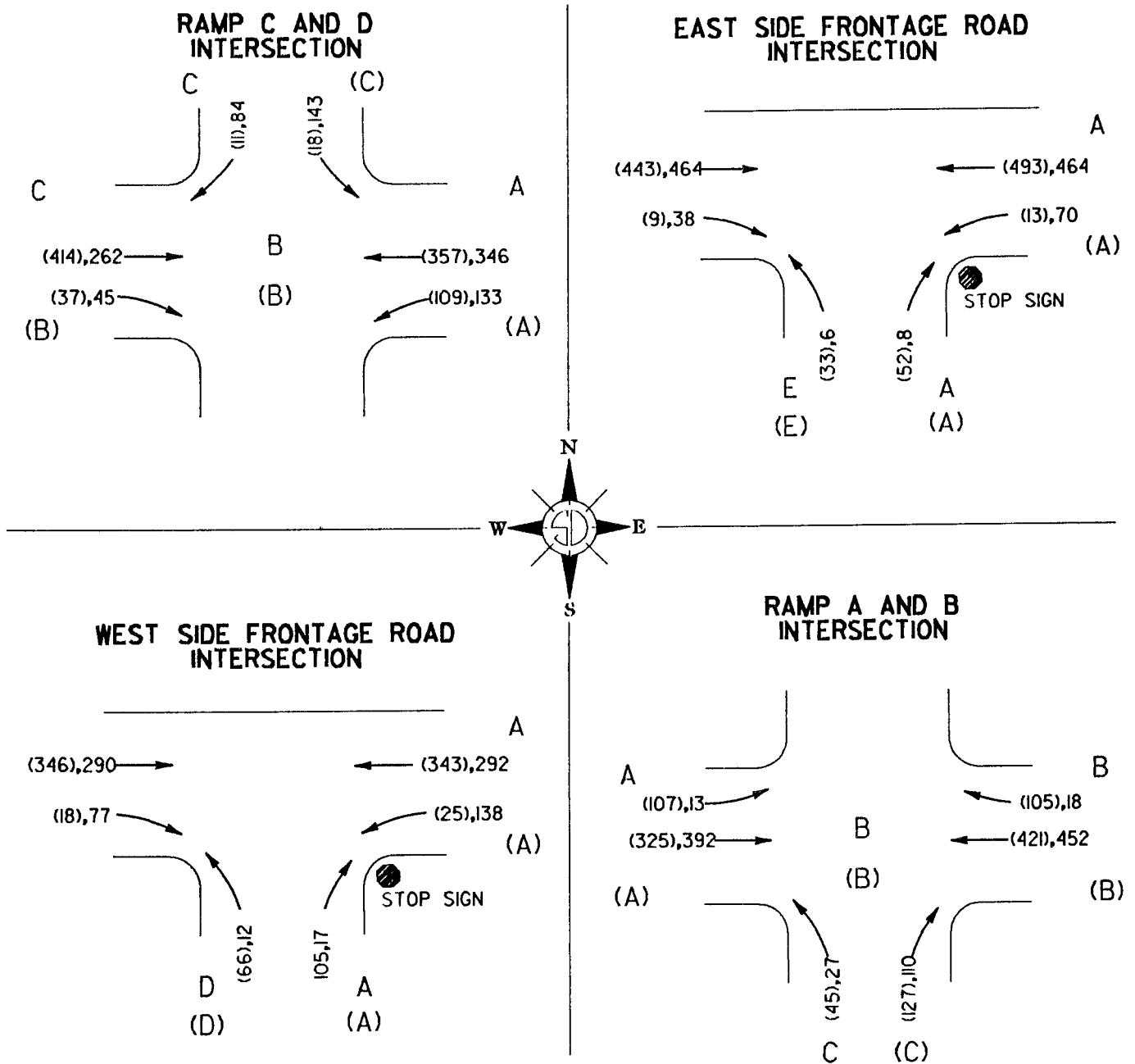

NOTE: NUMBERS IN PARENTHESES INDICATE P.M. PEAK HOUR MOVEMENTS. NO PARENTHESES INDICATE A.M. PEAK HOUR MOVEMENTS.

FIGURE 28

# INTERSECTION ANALYSIS AT MILEPOST 2 WITHOUT INTERCHANGE AT MILEPOST 1

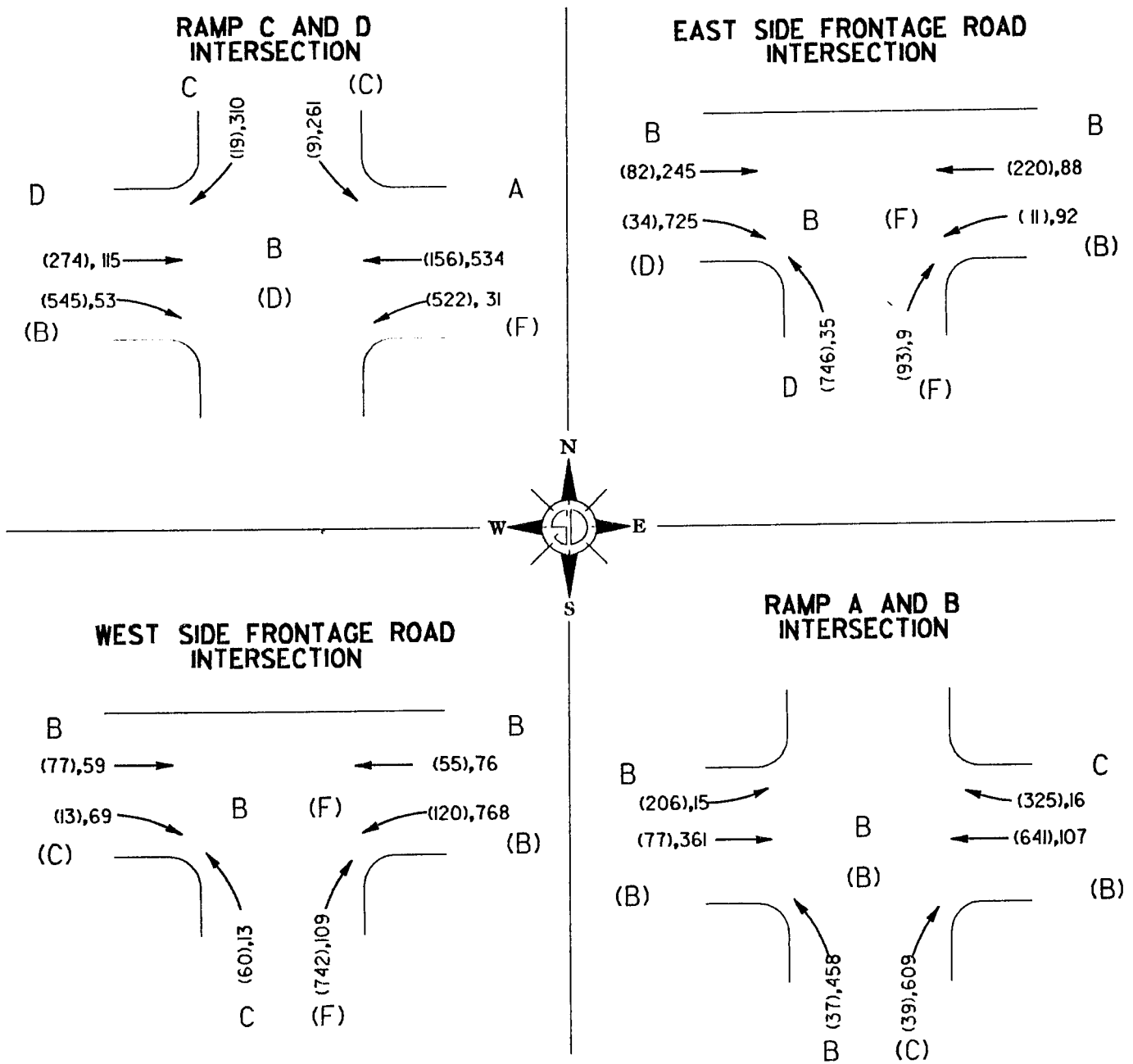

NOTE: NUMBERS IN PARENTHESES INDICATE P.M. PEAK HOUR MOVEMENTS. NO PARENTHESES INDICATE A.M. PEAK HOUR MOVEMENTS.



### Level of Service Analysis of the First Interchange in Iowa

A level of service analysis was also done on the first interchange on I-29 in Iowa (Riverside Boulevard) to assess the impact of the increase traffic generated by the Dakota Dunes Development at full build-out on the interchange. As Figure 29 shows, the level of service on the interstate and the ramps would remain at a level of "C" or above, indicating that the traffic generated by Dakota Dunes will have minimal impact on the interstate.

FIGURE 29

# PROJECTED PEAK HOUR VOLUME and LEVEL OF SERVICE

EXIT 150 NEAR THE RIVERSIDE NEIGHBORHOOD

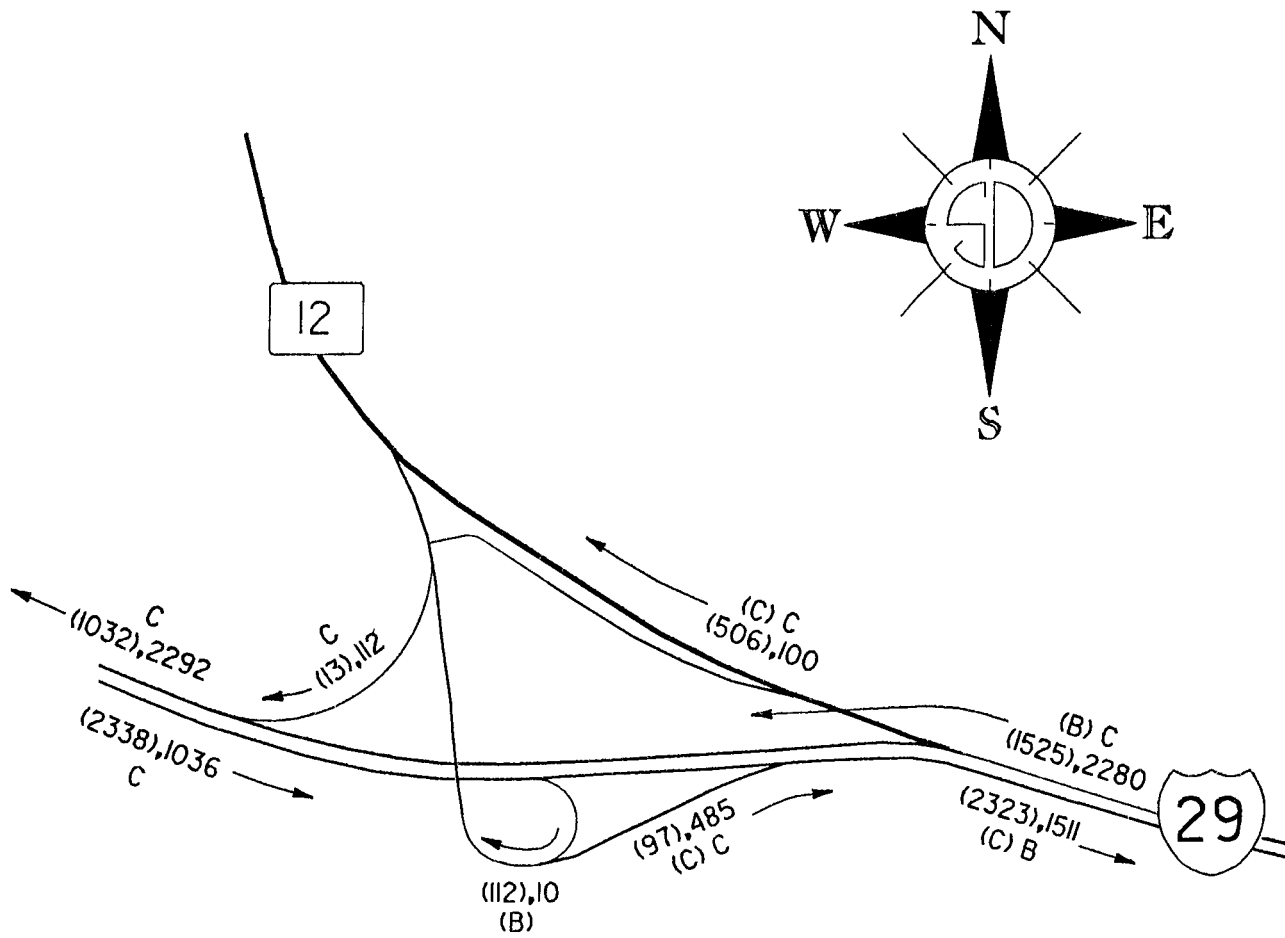

NOTE: NUMBERS IN PARENTHESES INDICATE P.M. PEAK HOUR MOVEMENTS.  
NO PARENTHESES INDICATE A.M. PEAK HOUR MOVEMENTS.

## COST BENEFIT ANALYSIS

The cost benefit analysis of the three alternatives indicate that Alternative 1 has a Benefit Ratio of 4.3 over Alternative 2 and a Benefit Ratio of 3.2 over Alternative 3. The projected road user savings on Alternative 1 was greater than those on Alternative 2 even though Alternative 2 has a projected lower cost of approximately five million dollars in 1989 dollars, or ten million dollars over the economic life cycle of the project. Traffic projections indicate that there will be lower traffic volumes and longer trips if users are required to use only the interchange at milepost two, resulting in the better benefit ratio for Alternative 1. With the construction of Alternative 1, the break-even point of a benefit-cost ratio of 1, would be reached with only 23 percent of the proposed planned development taking place, which indicates the cost-effectiveness of the project, even at a low level of development.

To facilitate the analysis, the level of development of Dakota Dunes was assumed to be 25 percent complete in five years, 50 percent complete in ten years, 75 percent complete in 15 years and totally completed in 20 years. All alternative expenditures were written off in twenty years. This created a 35 year economic recovery life cycle since the last expenditure for Alternative 1 will occur in 2005. Interest rates for capital recovery were assumed at 7.5 percent. The detailed cost benefit analysis is contained in the appendix to this study.

## SOURCES OF FUNDING

### Interchanges

The South Dakota Department of Transportation is requesting that a major portion of the funding for the interchanges at milepost one and milepost two come from South Dakota's Interstate 4R allocation. The state and the developer will pick up the other share of the project costs, as shown in Figure 30. The developer's share is composed mainly of the value of 46.5 acres of donated right-of-way at the interchange site and the borrow required to build the ramps, crossroads, and approaches.

### Frontage Roads

The developer and local government officials are going to determine the cost sharing arrangements for the east and west frontage roads, which are valued at \$1,593,000 and \$1,802,000 respectively. The cost to be shared by each entity will be decided based upon available funding and tax contributions.

Figure 30

Source of Funding for Interchange Improvements

Improvement Type	Funding Sources				Total
	Federal	State	Local	Developer	
Interchange at Milepost One	\$4,962,000	\$343,000	\$0	\$143,000*	\$5,448,000
Interchange at Milepost Two	3,275,000	320,000	0	0	3,595,000
Total	\$8,237,000	\$663,000	\$0	\$143,000	\$9,043,000

\* Represents the value of donated right-of-way and borrow.